



DS-K2800 Series Access Controller

User Manual

User Manual

©2018 Hangzhou Hikvision Digital Technology Co., Ltd.

This manual is applied for access controller.

Product Name	Serials
Access Controller	DS-K2801 Serials Access Controller
	DS-K2802 Serials Access Controller
	DS-K2804 Serials Access Controller

It includes instructions on how to use the Product. The software embodied in the Product is governed by the user license agreement covering that Product.

About this Manual

This Manual is subject to domestic and international copyright protection. Hangzhou Hikvision Digital Technology Co., Ltd. (“Hikvision”) reserves all rights to this manual. This manual cannot be reproduced, changed, translated, or distributed, partially or wholly, by any means, without the prior written permission of Hikvision.

Trademarks

HIKVISION and other Hikvision marks are the property of Hikvision and are registered trademarks or the subject of applications for the same by Hikvision and/or its affiliates. Other trademarks mentioned in this manual are the properties of their respective owners. No right of license is given to use such trademarks without express permission.

Disclaimer

TO THE MAXIMUM EXTENT PERMITTED BY APPLICABLE LAW, HIKVISION MAKES NO WARRANTIES, EXPRESS OR IMPLIED, INCLUDING WITHOUT LIMITATION THE IMPLIED WARRANTIES OF MERCHANTABILITY AND FITNESS FOR A PARTICULAR PURPOSE, REGARDING THIS MANUAL. HIKVISION DOES NOT WARRANT, GUARANTEE, OR MAKE ANY REPRESENTATIONS REGARDING THE USE OF THE MANUAL, OR THE CORRECTNESS, ACCURACY, OR RELIABILITY OF INFORMATION CONTAINED HEREIN. YOUR USE OF THIS MANUAL AND ANY RELIANCE ON THIS MANUAL SHALL BE WHOLLY AT YOUR OWN RISK AND RESPONSIBILITY.

REGARDING TO THE PRODUCT WITH INTERNET ACCESS, THE USE OF PRODUCT SHALL BE WHOLLY AT YOUR OWN RISKS. OUR COMPANY SHALL NOT TAKE ANY RESPONSIBILITIES FOR ABNORMAL OPERATION, PRIVACY LEAKAGE OR OTHER DAMAGES RESULTING FROM CYBER ATTACK, HACKER ATTACK, VIRUS INSPECTION, OR OTHER INTERNET SECURITY RISKS; HOWEVER, OUR COMPANY WILL PROVIDE TIMELY TECHNICAL SUPPORT IF REQUIRED.

SURVEILLANCE LAWS VARY BY JURISDICTION. PLEASE CHECK ALL RELEVANT LAWS IN YOUR JURISDICTION BEFORE USING THIS PRODUCT IN ORDER TO ENSURE THAT YOUR USE CONFORMS THE APPLICABLE LAW. OUR COMPANY SHALL NOT BE LIABLE IN THE EVENT THAT THIS PRODUCT IS USED WITH ILLEGITIMATE PURPOSES.

IN THE EVENT OF ANY CONFLICTS BETWEEN THIS MANUAL AND THE APPLICABLE LAW, THE LATER PREVAILS.

Support

Should you have any questions, please do not hesitate to contact your local dealer.

Regulatory Information

FCC Information

Please take attention that changes or modification not expressly approved by the party responsible for compliance could void the user's authority to operate the equipment.

FCC compliance: This equipment has been tested and found to comply with the limits for a Class B digital device, pursuant to part 15 of the FCC Rules. These limits are designed to provide reasonable protection against harmful interference in a residential installation. This equipment generates, uses and can radiate radio frequency energy and, if not installed and used in accordance with the instructions, may cause harmful interference to radio communications. However, there is no guarantee that interference will not occur in a particular installation. If this equipment does cause harmful interference to radio or television reception, which can be determined by turning the equipment off and on, the user is encouraged to try to correct the interference by one or more of the following measures:

- Reorient or relocate the receiving antenna.
- Increase the separation between the equipment and receiver.
- Connect the equipment into an outlet on a circuit different from that to which the receiver is connected.
- Consult the dealer or an experienced radio/TV technician for help.

FCC Conditions

This device complies with part 15 of the FCC Rules. Operation is subject to the following two conditions:

1. This device may not cause harmful interference.
2. This device must accept any interference received, including interference that may cause undesired operation.

EU Conformity Statement



This product and - if applicable - the supplied accessories too are marked with "CE" and comply therefore with the applicable harmonized European standards listed under the R&TTE Directive 1999/5/EC, the EMC Directive 2014/30/EU, the LVD Directive 2014/35/EU, the RoHS Directive 2011/65/EU.



2012/19/EU (WEEE directive): Products marked with this symbol cannot be disposed of as unsorted municipal waste in the European Union. For proper recycling, return this product to your local supplier upon the purchase of equivalent new equipment, or dispose of it at designated collection points. For more information see: www.recyclethis.info.



2006/66/EC (battery directive): This product contains a battery that cannot be disposed of as unsorted municipal waste in the European Union. See the product documentation for specific battery information. The battery is marked with this symbol, which may include lettering to indicate cadmium (Cd), lead (Pb), or mercury (Hg). For proper recycling, return the battery to your supplier or to a designated collection point. For more information see: www.recyclethis.info.

Industry Canada ICES-003 Compliance

This device meets the CAN ICES-3 (A)/NMB-3(A) standards requirements.

Preventive and Cautionary Tips

Before connecting and operating your device, please be advised of the following tips:

- Ensure unit is installed in a well-ventilated, dust-free environment.
- Keep all liquids away from the device.
- Ensure environmental conditions meet factory specifications.
- Ensure unit is properly secured to a rack or shelf. Major shocks or jolts to the unit as a result of dropping it may cause damage to the sensitive electronics within the unit.
- Use the device in conjunction with an UPS if possible.
- Power down the unit before connecting and disconnecting accessories and peripherals.
- A factory recommended HDD should be used for this device.

Improper use or replacement of the battery may result in hazard of explosion. Replace with the same or equivalent type only. Dispose of used batteries according to the instructions provided by the manufacturer.



Safety Instruction

These instructions are intended to ensure that user can use the product correctly to avoid danger or property loss.

The precaution measure is divided into **Warnings** and **Cautions**:

Warnings: Neglecting any of the warnings may cause serious injury or death.

Cautions: Neglecting any of the cautions may cause injury or equipment damage.

	
Warnings Follow these safeguards to prevent serious injury or death.	Cautions Follow these precautions to prevent potential injury or material damage.



Warnings

- All the electronic operation should be strictly compliance with the electrical safety regulations, fire prevention regulations and other related regulations in your local region.
- Please use the power adapter, which is provided by normal company. The power consumption cannot be less than the required value.
- Do not connect several devices to one power adapter as adapter overload may cause over-heat or fire hazard.
- Please make sure that the power has been disconnected before you wire, install or dismantle the device.
- When the product is installed on wall or ceiling, the device shall be firmly fixed.
- If smoke, odors or noise rise from the device, turn off the power at once and unplug the power cable, and then please contact the service center.
- If the product does not work properly, please contact your dealer or the nearest service center. Never attempt to disassemble the device yourself. (We shall not assume any responsibility for problems caused by unauthorized repair or maintenance.)



Cautions

- Do not drop the device or subject it to physical shock, and do not expose it to high electromagnetism radiation. Avoid the equipment installation on vibrations surface or places subject to shock (ignorance can cause equipment damage).
- Do not place the device in extremely hot (refer to the specification of the device for the detailed operating temperature), cold, dusty or damp locations, and do not expose it to high electromagnetic radiation. The appropriate operation temperature is 0°C to +45°C, and the storage temperature should be -10°C to +55°C.
- The device cover for indoor use shall be kept from rain and moisture.
- Exposing the equipment to direct sun light, low ventilation or heat source such as heater or radiator is forbidden (ignorance can cause fire danger).
- Do not aim the device at the sun or extra bright places. A blooming or smear may occur otherwise (which is not a malfunction however), and affecting the endurance of sensor at the same time.
- Please use the provided glove when open up the device cover, avoid direct contact with the device cover, because the acidic sweat of the fingers may erode the surface coating of the device cover.
- Please use a soft and dry cloth when clean inside and outside surfaces of the device cover, do not use alkaline detergents.

- Please keep all wrappers after unpack them for future use. In case of any failure occurred, you need to return the device to the factory with the original wrapper. Transportation without the original wrapper may result in damage on the device and lead to additional costs.
- Improper use or replacement of the battery may result in hazard of explosion. Replace with the same or equivalent type only. Dispose of used batteries according to the instructions provided by the battery manufacturer.

Table of Contents

Chapter 1	Product Description	1
1.1	Overview	1
1.2	Main Features	1
Chapter 2	Component Description	2
Chapter 3	Terminal Connection	3
3.1	DS-K2801 Terminal Description.....	3
3.2	DS-K2802 Terminal Description.....	5
3.3	DS-K2804 Terminal Description.....	7
Chapter 4	External Device Wiring	10
4.1	Card Reader Wiring	10
4.1.1	Wiegand Card Reader Wiring	10
4.1.2	DS-K1800 Series Card Reader Wiring.....	10
4.2	DS-K2801 External Terminals	10
4.2.1	Installation of Cathode Lock.....	11
4.2.2	Installation of Anode Lock.....	11
4.3	Connecting the External Alarm Device	12
4.4	Door Button Wiring Diagram	12
4.5	The Connection of Magnetics Detection	13
4.6	Connecting Power Supply	13
Chapter 5	Settings	14
5.1	Initializing the Hardware	14
5.2	Relay Input NO/NC	14
5.2.1	Lock Relay Output	14
5.2.2	Alarm Relay Output Status	15
Chapter 6	Activating the Access Control Terminal	17
6.1	Activating via SADP Software	17
6.2	Activating via Client Software	18
Chapter 7	Client Operation	21
7.1	Function Module	21
7.2	User Registration and Login	21
7.3	System Configuration	22
7.4	Access Control Management	23
7.4.1	Adding Access Control Device	24
7.4.2	Viewing Device Status.....	33

7.4.3	Editing Basic Information	33
7.4.4	Remote Configuration	33
7.5	Person and Card Management	39
7.5.1	Organization Management	39
7.5.2	Person Management	40
7.6	Schedule and Template	48
7.6.1	Week Schedule	49
7.6.2	Holiday Group	50
7.6.3	Template.....	51
7.7	Permission Configuration	53
7.7.1	Adding Permission.....	54
7.7.2	Applying Permission	55
7.8	Advanced Functions	55
7.8.1	Access Control Parameters.....	56
7.8.2	Card Reader Authentication.....	57
7.8.3	Open Door with First Card	58
7.8.4	Anti-Passing Back	60
7.8.5	Authentication Password	61
7.8.6	Custom Wiegand.....	62
7.9	Searching Access Control Event	64
7.10	Access Control Event Configuration	65
7.10.1	Access Control Event Linkage	65
7.10.2	Access Control Alarm Input Linkage.....	67
7.10.3	Event Card Linkage	67
7.10.4	Cross-Device Linkage.....	69
7.11	Door Status Management	70
7.11.1	Access Control Group Management	70
7.11.2	Anti-control the Access Control Point (Door).....	72
7.11.3	Status Duration Configuration	73
7.11.4	Real-time Card Swiping Record	75
7.11.5	Real-time Access Control Alarm	75
7.12	Arming Control.....	76
Appendix A Sound Prompt and Indicator		78
Appendix B Custom Wiegand Rule.....		79

Chapter 1 Product Description

1.1 Overview

DS-K2800 is a powerful and stable access controller, using the logical architecture design. DS-K2800 is designed with TCP/IP network interface and its signal processed with special encryption and can be run offline. Anti-tampering function is also supported.

1.2 Main Features

- The access controller is equipped with 32-bit high-speed processor
- Supports TCP/IP network communication, with self-adaptive network interface. The communication data is specially encrypted to relieve the concern of privacy leak
- Supports recognition and storage of card number with maximum length of 20
- The access controller can store 10 thousand legal cards and 50 thousand card swiping records
- Supports first card open-door and first card authorization function, super card and super password function, online upgrade function and remote control of the doors
- Supports Wiegand interface for accessing card reader. Wiegand interface supports W26/W34 and is seamlessly compatible with third-party card reader with Wiegand interface
- Supports various card types as normal/ blocklist/ patrol/ guest/ duress/ super card, card for door extended opening, etc.
- Supports time synchronization via NTP, manual or automatic method
- Supports record storage function when it is offline and insufficient storage space storage alarm function
- The access controller has watchdog design
- Data can be permanently saved after the access controller is powered off.
- Supports I/O linkage, and event linkage
- Supports alarm of offline event exceeding 90%
- Multiple event upload methods: channel, center group, and listening
- 500 groups of authentication code
- Anti-pass-back function.

Chapter 2 Component Description

Take DS-K2804 as an example, the component schematic diagram is shown below.

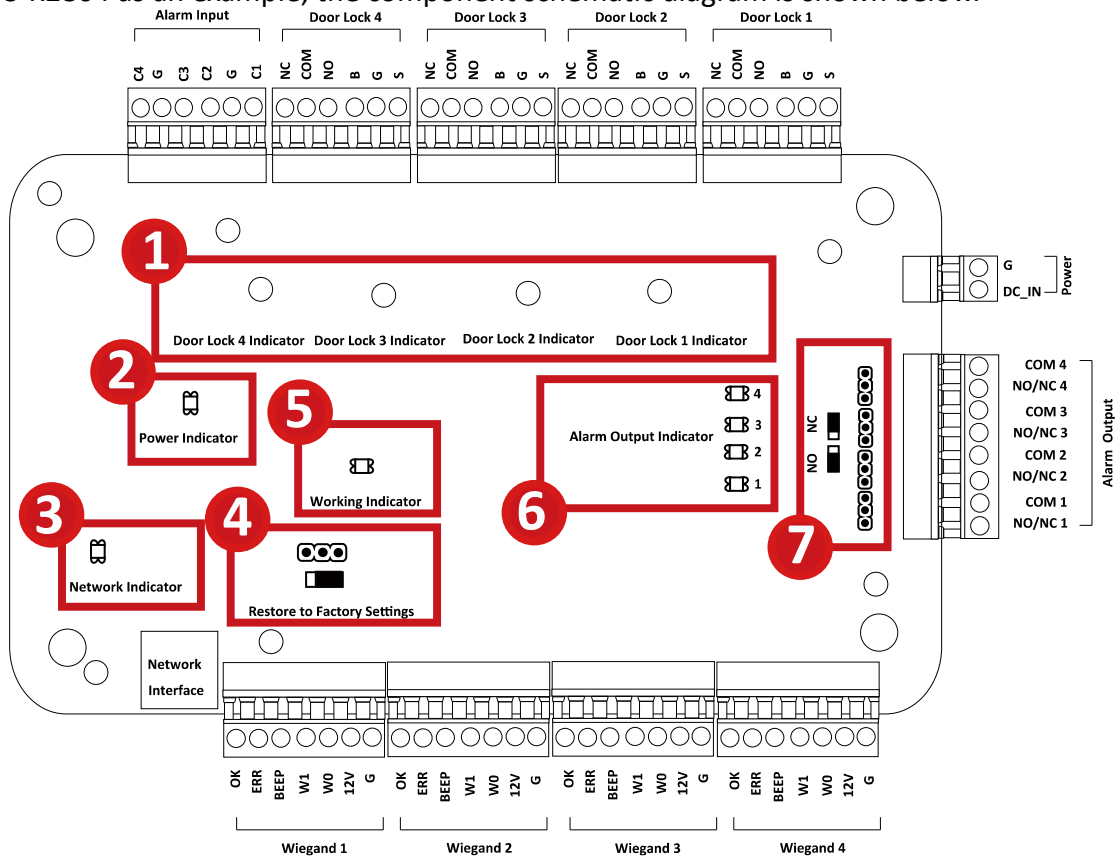

DS-K2800 component descriptions are as follows:

No.	Component Description		
	DS-K2801	DS-K2802	DS-K2804
1	Door Lock 1 Indicator	Door Lock 1/2 Indicator	Door Lock 1/2/3/4 Indicator
2	Power Indicator		
3	Network Indicator		
4	Jumper Cap for Restoring Factory Settings		
5	Working Indicator		
6	Alarm Output Indicator		
7	Alarm Output (NO/NC) Jumper Cap		

Chapter 3 Terminal Connection

3.1 DS-K2801 Terminal Description

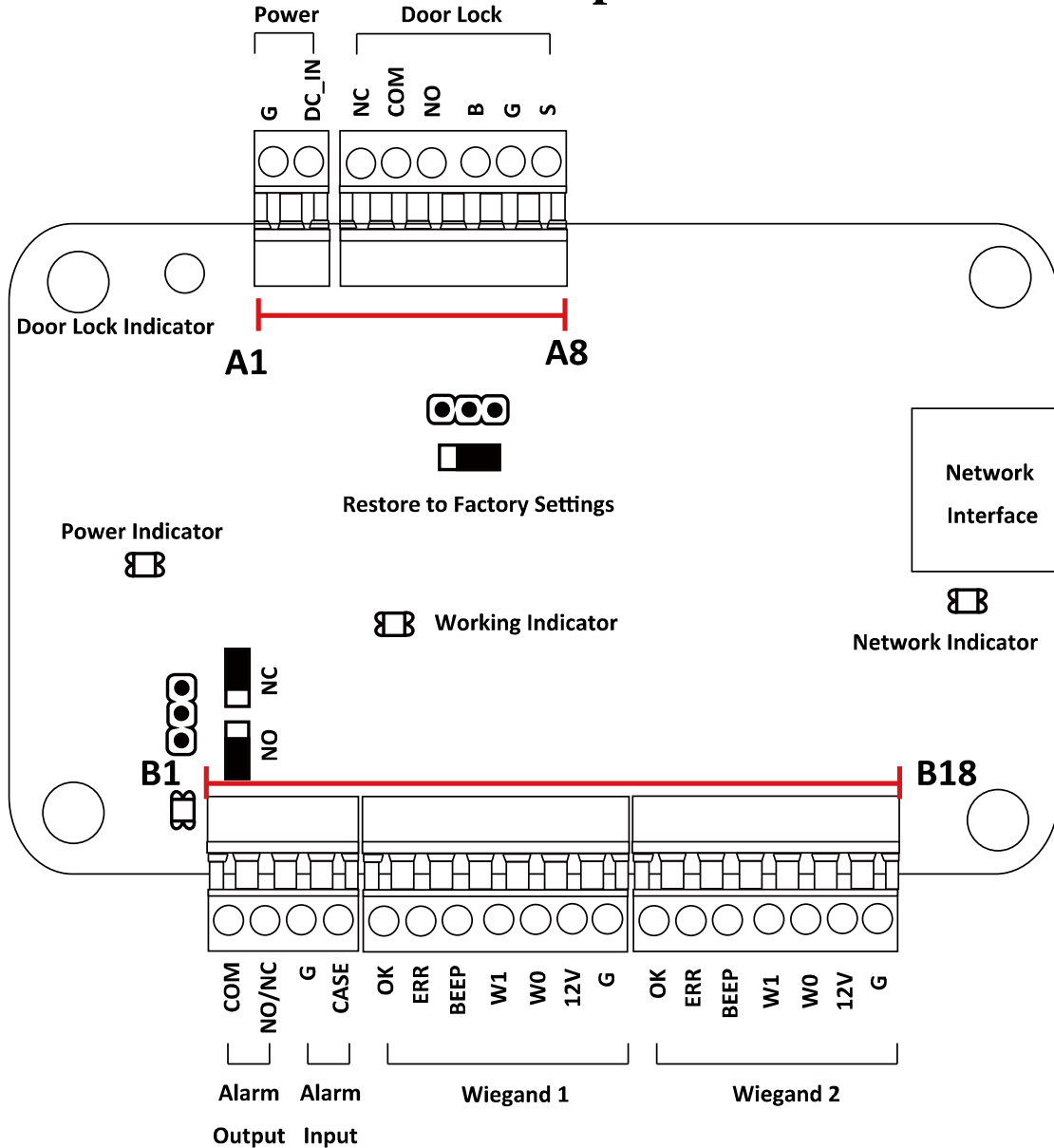

DS-K2801 Terminal descriptions are as follows:

No.	DS-K2801		
A1	Power	GND	DC12V Grounding
A2		+12V	DC12V Input
A3	Door	NC	Door Lock Relay Output
A4		COM	
A5		NO	
A6		BUTTON	Door Button Input
A7		GND	Grounding

Access Controller - User Manual

No.	DS-K2801		
A8		SENSOR	Door Magnetic detector
B1	Alarm Output	COM	Alarm Relay Output (Dry Contact)
B2		NO/NC	
B3	Alarm Input	GND	Grounding
B4		IN	Event Input
B5	Wiegand Card Reader 1	OK	Indicator of Card Reader Control Output (Valid Card Output)
B6		ERR	Indicator of Card Reader Control Output (Invalid Card Output)
B7		BZ	Card Reader Buzzer Control Output
B8		W1	Wiegand Head Read Data Input Data1
B9		W0	Wiegand Head Read Data Input Data0
B10		PWR	Card Reader Power Output
B11		GND	
B12		Wiegand Card Reader 2	OK
B13	ERR		Indicator of Card Reader Control Output (Invalid Card Output)
B14	BZ		Card Reader Buzzer Control Output
B15	W1		Wiegand Head Read Data Input Data1
B16	W0		Wiegand Head Read Data Input Data0
B17	PWR		Card Reader Power Output
B18	GND		

3.2 DS-K2802 Terminal Description

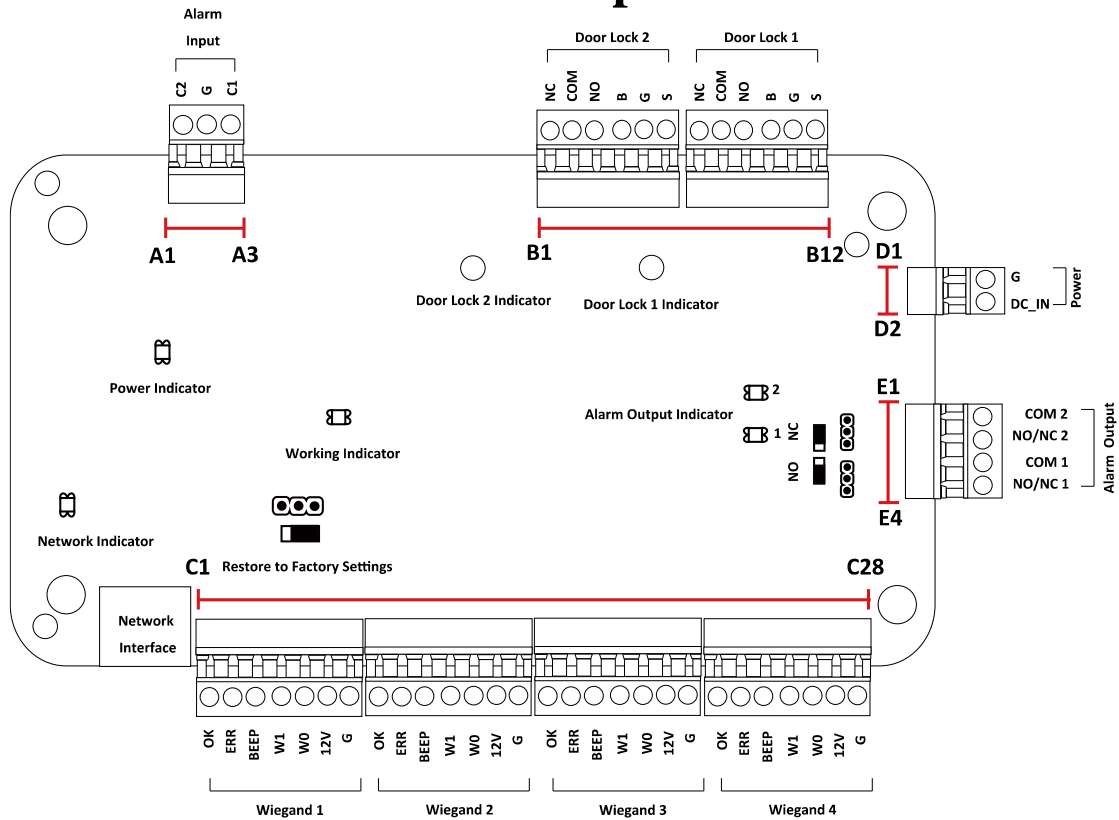

DS-K2802 Terminal descriptions are as follows:

No.	DS-K2802		
A1	Alarm Input	IN2	Event Input 2
A2		GND	Grounding
A3		IN1	Event Input 1
B1	Door 2	NC	Door Lock Relay Output (Dry Contact)
B2		COM	
B3		NO	
B4		BUTTON	Door Button Input
B5		GND	Grounding
B6		SENSOR	Door Magnetic detector
B7	Door 1	NC	Door Lock Relay Output (Dry Contact)
B8		COM	
B9		NO	
B10		BUTTON	Door Button Input
B11		GND	Grounding
B12		SENSOR	Door Magnetic detector
D1	Power	GND	DC12V Grounding
D2		+12V	DC12V Input
E1	Alarm Output 2	COM2	Alarm Relay Output 2 (Dry Contact)
E2		NO/NC2	

Access Controller • User Manual

No.	DS-K2802		
E3	Alarm Output 1	COM1	Alarm Relay Output 1 (Dry Contact)
E4		NO/NC1	
C1	Wiegand Card Reader 1	OK	Indicator of Card Reader Control Output (Valid Card Output)
C2		ERR	Indicator of Card Reader Control Output (Invalid Card Output)
C3		BZ	Card Reader Buzzer Control Output
C4		W1	Wiegand Head Read Data Input Data1
C5		W0	Wiegand Head Read Data Input Data0
C6		PWR	Card Reader Power Output
C7		GND	
C8	Wiegand Card Reader 2	OK	Indicator of Card Reader Control Output (Valid Card Output)
C9		ERR	Indicator of Card Reader Control Output (Invalid Card Output)
C10		BZ	Card Reader Buzzer Control Output
C11		W1	Wiegand Head Read Data Input Data1
C12		W0	Wiegand Head Read Data Input Data0
C13		PWR	Card Reader Power Output
C14		GND	
C15	Wiegand Card Reader 3	OK	Indicator of Card Reader Control Output (Valid Card Output)
C16		ERR	Indicator of Card Reader Control Output (Invalid Card Output)
C17		BZ	Card Reader Buzzer Control Output
C18		W1	Wiegand Head Read Data Input Data1
C19		W0	Wiegand Head Read Data Input Data0
C20		PWR	Card Reader Power Output
C21		GND	
C22	Wiegand Card Reader 4	OK	Indicator of Card Reader Control Output (Valid Card Output)
C23		ERR	Indicator of Card Reader Control Output (Invalid Card Output)
C24		BZ	Card Reader Buzzer Control Output
C25		W1	Wiegand Head Read Data Input Data1
C26		W0	Wiegand Head Read Data Input Data0
C27		PWR	Card Reader Power Output
C28		GND	

3.3 DS-K2804 Terminal Description

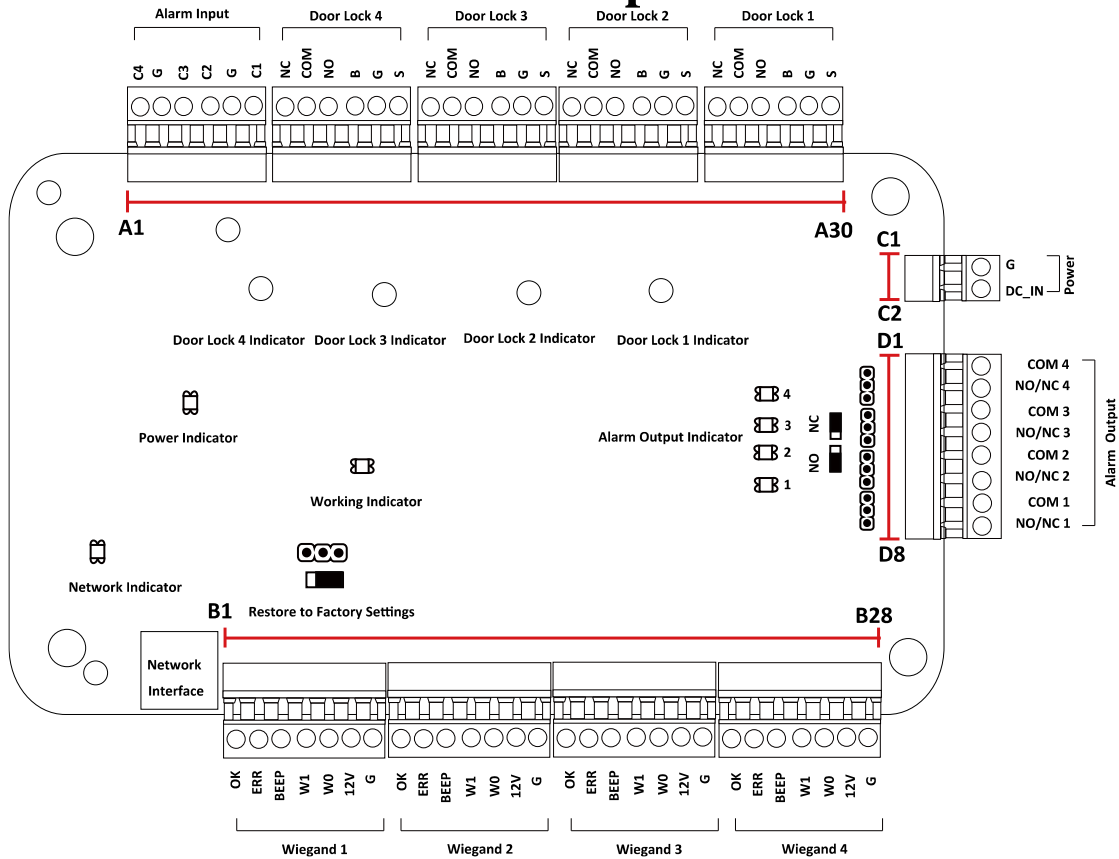

DS-K2804 Terminal descriptions are as follows:

No.	DS-K2804		
A1	Alarm Input	IN4	Event Input 4
A2		GND	Grounding
A3		IN3	Event Input 3
A4		IN2	Event Input 2
A5		GND	Grounding
A6		IN1	Event Input 1
A7	Door 4	NC	Door Lock Relay Output (Dry Contact)
A8		COM	
A9		NO	
A10		BUTTON	Door Button Input
A11		GND	Grounding
A12		SENSOR	Door Magnetic detector
A13	Door 3	NC	Door Lock Relay Output (Dry Contact)
A14		COM	
A15		NO	
A16		BUTTON	Door Button Input
A17		GND	Grounding
A18		SENSOR	Door Magnetic detector

Access Controller • User Manual

No.	DS-K2804		
A19	Door 2	NC	Door Lock Relay Output (Dry Contact)
A20		COM	
A21		NO	
A22		BUTTON	Door Button Input
A23		GND	Grounding
A24		SENSOR	Door Magnetic detector
A25	Door 1	NC	Door Lock Relay Output (Dry Contact)
A26		COM	
A27		NO	
A28		BUTTON	Door Button Input
A29		GND	Grounding
A30		SENSOR	Door Magnetic detector
B1	Wiegand Card Reader 1	OK	Indicator of Card Reader Control Output (Valid Card Output)
B2		ERR	Indicator of Card Reader Control Output (Invalid Card Output)
B3		BZ	Card Reader Buzzer Control Output
B4		W1	Wiegand Head Read Data Input Data1
B5		W0	Wiegand Head Read Data Input Data0
B6		PWR	Card Reader Power Output
B7		GND	
B8	Wiegand Card Reader 2	OK	Indicator of Card Reader Control Output (Valid Card Output)
B9		ERR	Indicator of Card Reader Control Output (Invalid Card Output)
B10		BZ	Card Reader Buzzer Control Output
B11		W1	Wiegand Head Read Data Input Data1
B12		W0	Wiegand Head Read Data Input Data0
B13		PWR	Card Reader Power Output
B14		GND	
B15	Wiegand Card Reader 3	OK	Indicator of Card Reader Control Output (Valid Card Output)
B16		ERR	Indicator of Card Reader Control Output (Invalid Card Output)
B17		BZ	Card Reader Buzzer Control Output
B18		W1	Wiegand Head Read Data Input Data1
B19		W0	Wiegand Head Read Data Input Data0
B20		PWR	Card Reader Power Output
B21		GND	
B22	Wiegand Card Reader 4	OK	Indicator of Card Reader Control Output (Valid Card Output)
B23		ERR	Indicator of Card Reader Control Output (Invalid Card Output)

No.	DS-K2804		
B24		BZ	Card Reader Buzzer Control Output
B25		W1	Wiegand Head Read Data Input Data1
B26		W0	Wiegand Head Read Data Input Data0
B27		PWR	Card Reader Power Output
B28		GND	
C1	Power	GND	DC12V Grounding
C2		+12V	DC12V Input
D1	Alarm Output 4	COM4	Alarm Relay Output 4 (Dry Contact)
D2		NO/NC4	
D3	Alarm Output 3	COM3	Alarm Relay Output 3 (Dry Contact)
D4		NO/NC3	
D5	Alarm Output 2	COM2	Alarm Relay Output 2 (Dry Contact)
D6		NO/NC2	
D7	Alarm Output 1	COM1	Alarm Relay Output 1 (Dry Contact)
D8		NO/NC1	

Notes:

- The Alarm input hardware interface is normally open by default. So only the normally open signal is allowed. It can be linked to the buzzer of the card reader and access controller, and the alarm relay output and open door relat output.
- For single-door access controller, the Wiegand card reader 1 and 2 respectively correspond to the entering and exiting card readers of door 1. For two-door access controller, the Wiegand card reader 1 and 2 respectively correspond to the entering and exiting card readers of door 1 , and the Wiegand card reader 3 and 4 respectively correspond to the entering and exiting card readers of door 2. For four-door access controller, the Wiegand card reader 1, 2, 3 and 4 respectively correspond to the entering card readers of door 1, 2, 3, and 4.

Chapter 4 External Device Wiring

4.1 Card Reader Wiring

4.1.1 Wiegand Card Reader Wiring

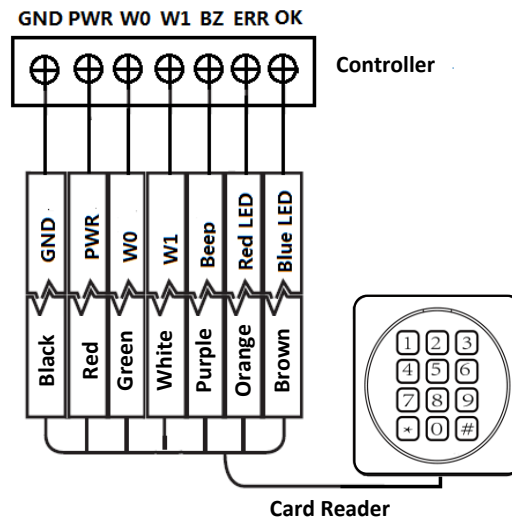

Note: You must connect the OK/ERR/BZ, if using access controller to control the LED and buzzer of the Wiegand card reader.

4.1.2 DS-K1800 Series Card Reader Wiring

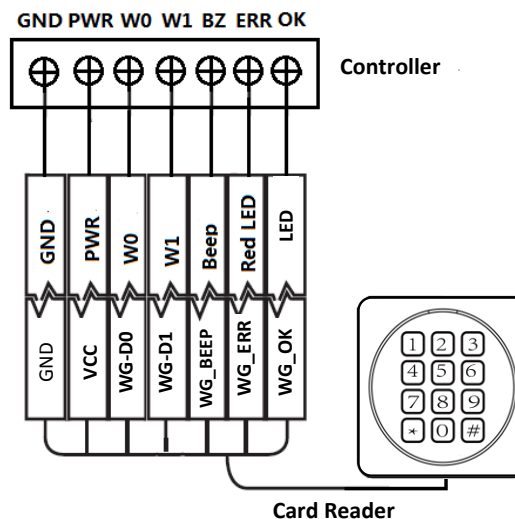

4.2 DS-K2801 External Terminals

4.2.1 Installation of Cathode Lock

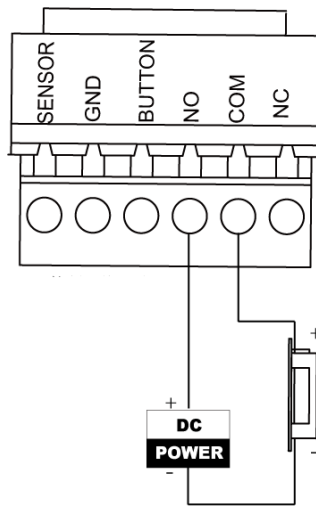

4.2.2 Installation of Anode Lock

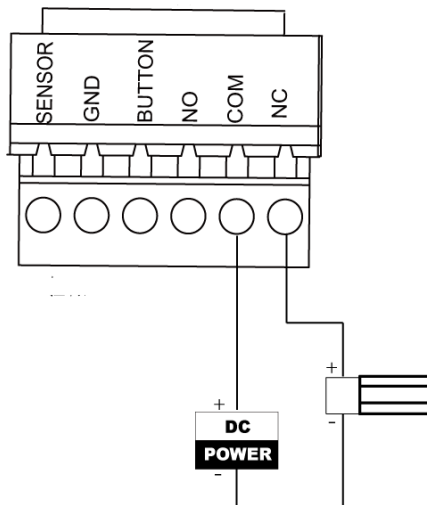

4.3 Connecting the External Alarm Device

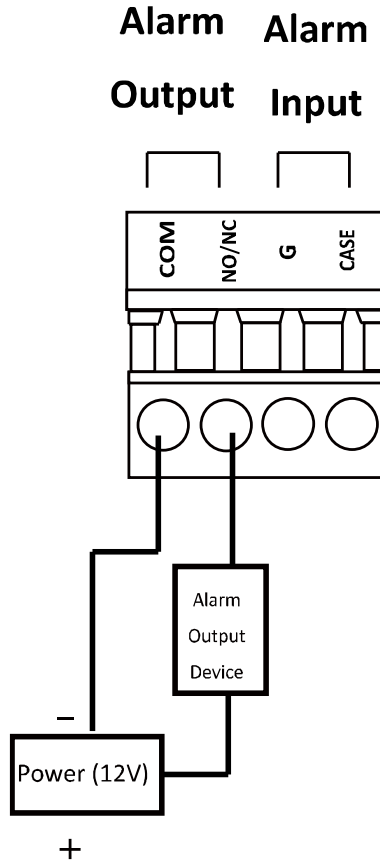

4.4 Door Button Wiring Diagram

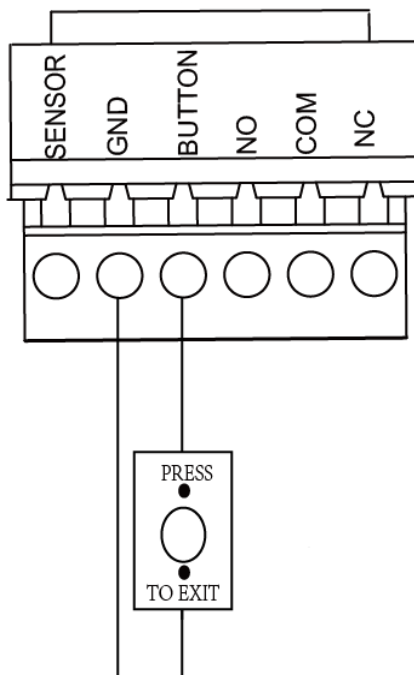

4.5 The Connection of Magnetics Detection

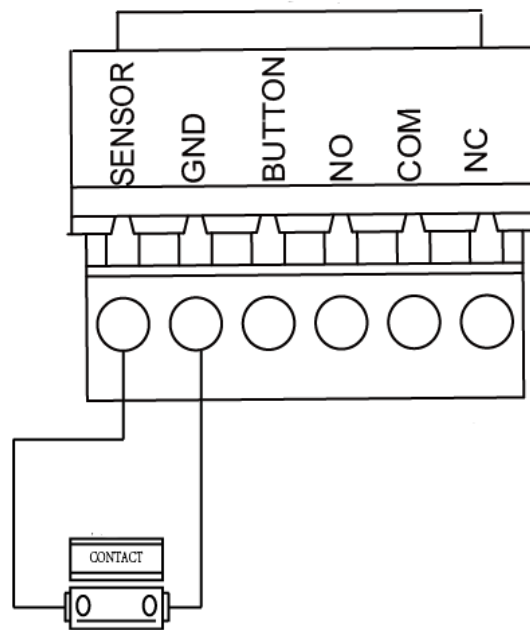

4.6 Connecting Power Supply

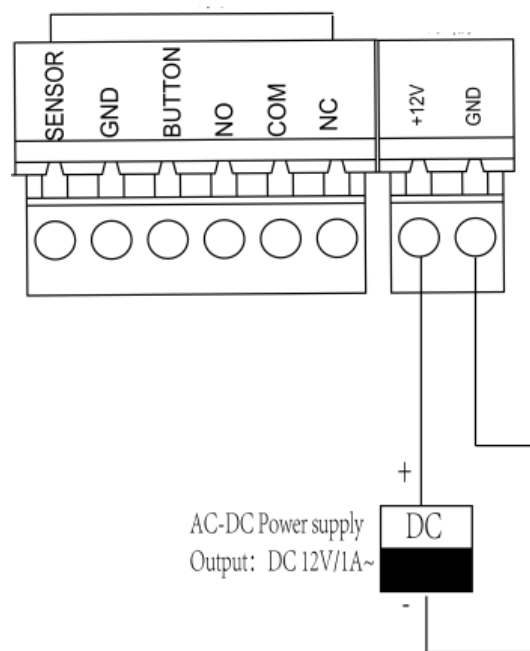

Chapter 5 Settings

5.1 Initializing the Hardware

Option 1:

Steps:

1. Remove the jumper cap from the Normal terminal.
2. Disconnect the power and restart the access controller. The controller buzzer buzzes a long beep.
3. When the beep stopped, plug the jumper cap back to Normal.
4. Disconnect the power and restart the access controller.

Option 2:

Steps:

1. Jump the jumper cap from Normal to Initial.
2. Disconnect the power and restart the access controller. The controller buzzer buzzes a long beep.
3. When the beep stopped, jump the jumper cap back to Normal.
4. Disconnect the power and restart the access controller.

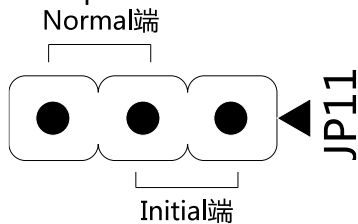

DS-K2801 Initialization Dial-up

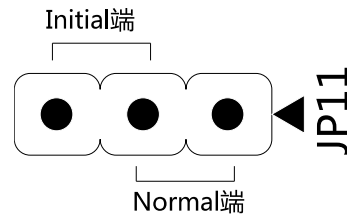

DS-K2802/DS-K2804 Initialization Dial-up

Note: The initializing of the hardware will restore all the parameters to the default setting and all the device events are wiping out.

5.2 Relay Input NO/NC

5.2.1 Lock Relay Output

Lock Relay Normally Open Status:

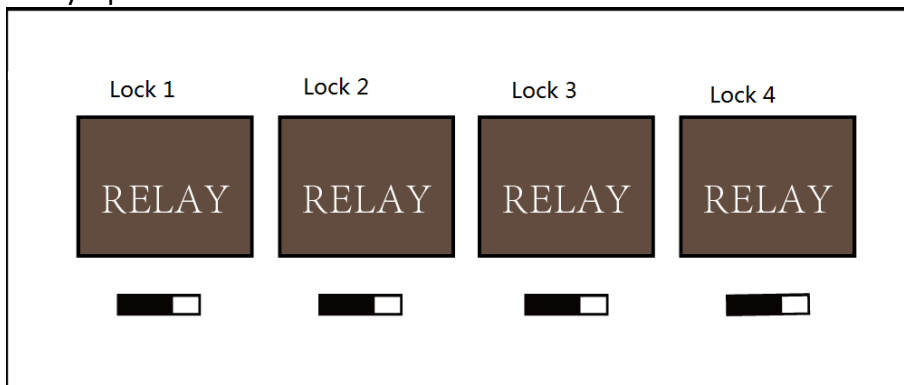

Lock Relay Normally Closed Status:

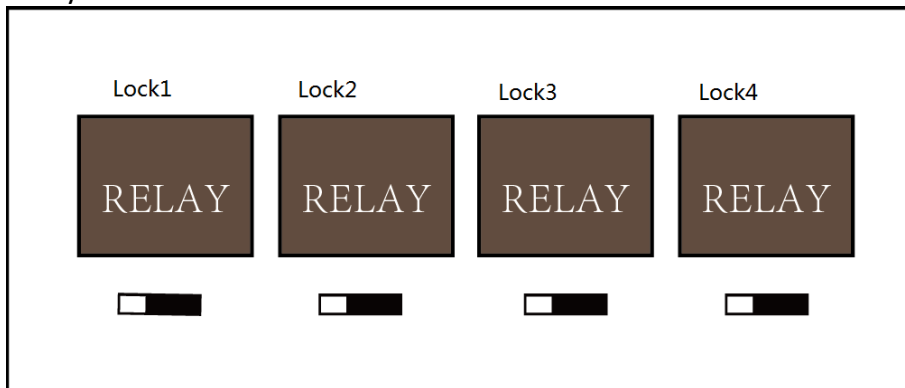

5.2.2 Alarm Relay Output Status

Alarm Relay Output Normally Open:

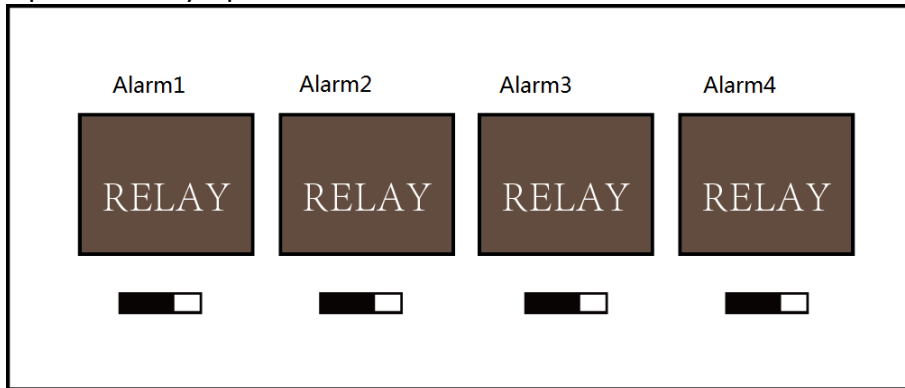

Alarm Relay Output Normally Closed:

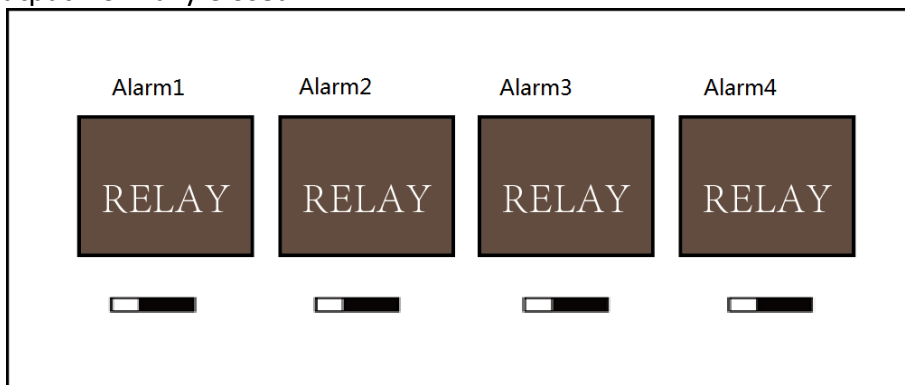

Work Flow of Software

For detailed information, please see the user manual of the client software.
Refer to the following work flow:

Access Controller - User Manual

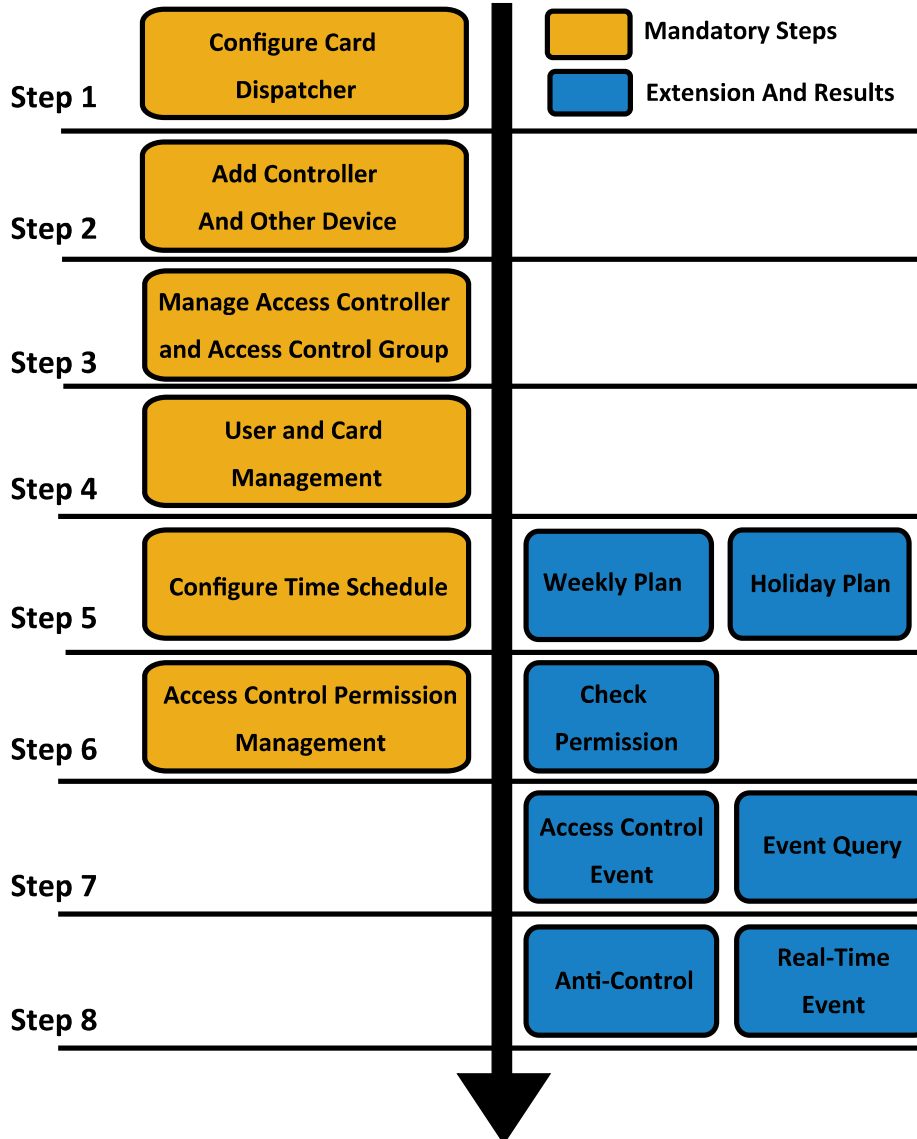

Chapter 6 Activating the Access Control Terminal

Purpose:

You are required to activate the terminal first before using it. Activation via SADP, and Activation via client software are supported. The default values of the control terminal are as follows.

- The default IP address: 192.0.0.64.
- The default port No.: 8000.
- The default user name: admin.

6.1 Activating via SADP Software

SADP software is used for detecting the online device, activating the device, and resetting the password.

Get the SADP software from the supplied disk, and install the SADP according to the prompts. Follow the steps to activate the control panel.

Steps:

1. Run the SADP software to search the online devices.
2. Check the device status from the device list, and select an inactive device.

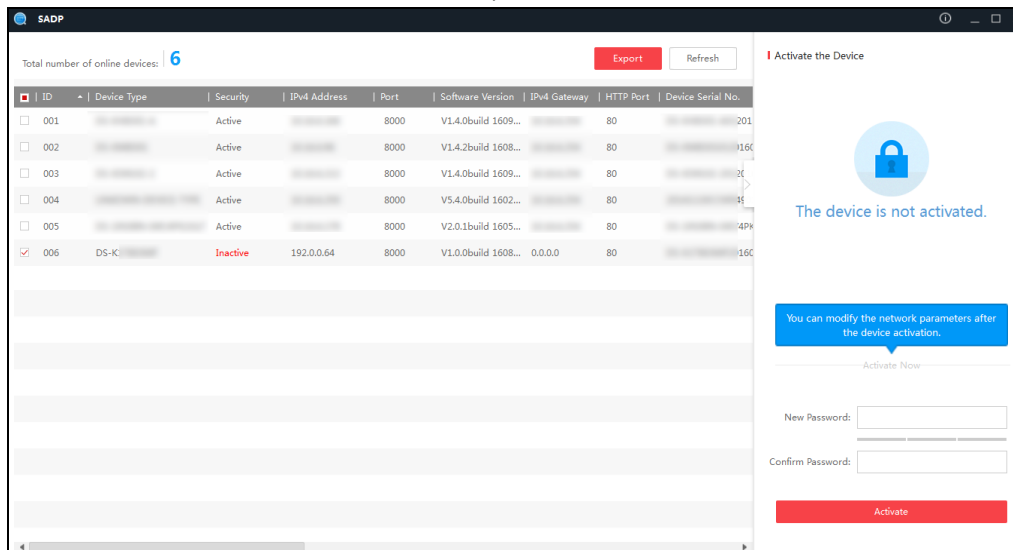

3. Create a password and input the password in the password field, and confirm the password.



STRONG PASSWORD RECOMMENDED— We highly recommend you create a strong password of your own choosing (using a minimum of 8 characters, including upper case letters, lower case letters, numbers, and special characters) in order to increase the security of your product. And we recommend you reset your password regularly, especially in the high security system, resetting the password monthly or weekly can better protect your product.

4. Click **Activate** to activate the device.
5. Check the activated device. You can change the device IP address to the same network

segment with your computer by either modifying the IP address manually or checking the checkbox of Enable DHCP.

Modify Network Parameters

Enable DHCP

Device Serial No.:

IP Address:

Port:

Subnet Mask:

Gateway:

IPv6 Address:

IPv6 Gateway:

IPv6 Prefix Length:

HTTP Port:

Security Verification

Admin Password:

[Modify](#)

[Forgot Password](#)

6. Input the password and click the **Modify** button to activate your IP address modification.

6.2 Activating via Client Software

The client software is versatile video management software for multiple kinds of devices. Get the client software from the supplied disk, and install the software according to the prompts. Follow the steps to activate the control panel.

Steps:

1. Run the client software and the control panel of the software pops up, as shown in the figure below.

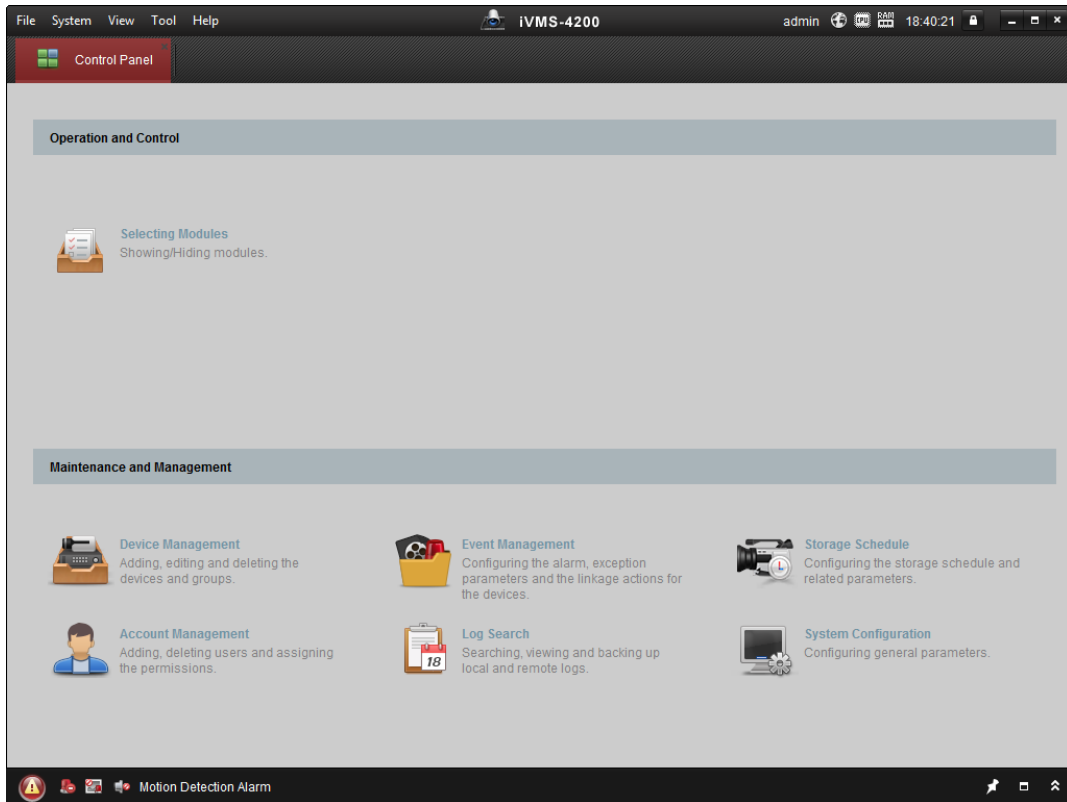

2. Click the **Device Management** to enter the Device Management interface.
3. Check the device status from the device list, and select an inactive device.

IP	Device Type	Firmware Version	Security	Server Port	Device Serial No.	Start Time
192.0.0.64			Active	8000		2017-01
192.168.1.64			Inactive	8000		2017-01

4. Click the **Activate** button to pop up the Activation interface.
5. In the pop-up window, create a password in the password field, and confirm the password.



STRONG PASSWORD RECOMMENDED— We highly recommend you create a strong password of your own choosing (using a minimum of 8 characters, including upper case letters, lower case letters, numbers, and special characters) in order to increase the security of your product. And we recommend you reset your password regularly, especially in the high security system, resetting the password monthly or weekly can better protect your product.



The screenshot shows a dialog box titled "Activate Device" with a close button (X) in the top right corner. It contains two text input fields. The first is labeled "Password:" and the second is labeled "Confirm Pas...". Between these fields is a message: "The password (8 to 16 characters) should contain two or more of the following character types: numeric, low...". At the bottom of the dialog are two buttons: "OK" and "Cancel".

6. Click **OK** button to start activation.
7. Click the **Modify Netinfor** button to pop up the Network Parameter Modification interface.
8. Change the device IP address to the same network segment with your computer by either modifying the IP address manually.
9. Input the password and click the **OK** button to save the settings.

Chapter 7 Client Operation

You can set and operate the access control devices via the client software. This chapter will introduce the access control device related operations in the client software. For integrated operations, refer to *User Manual of iVMS-4200 Client Software*.

7.1 Function Module

Control Panel of iVMS-4200:

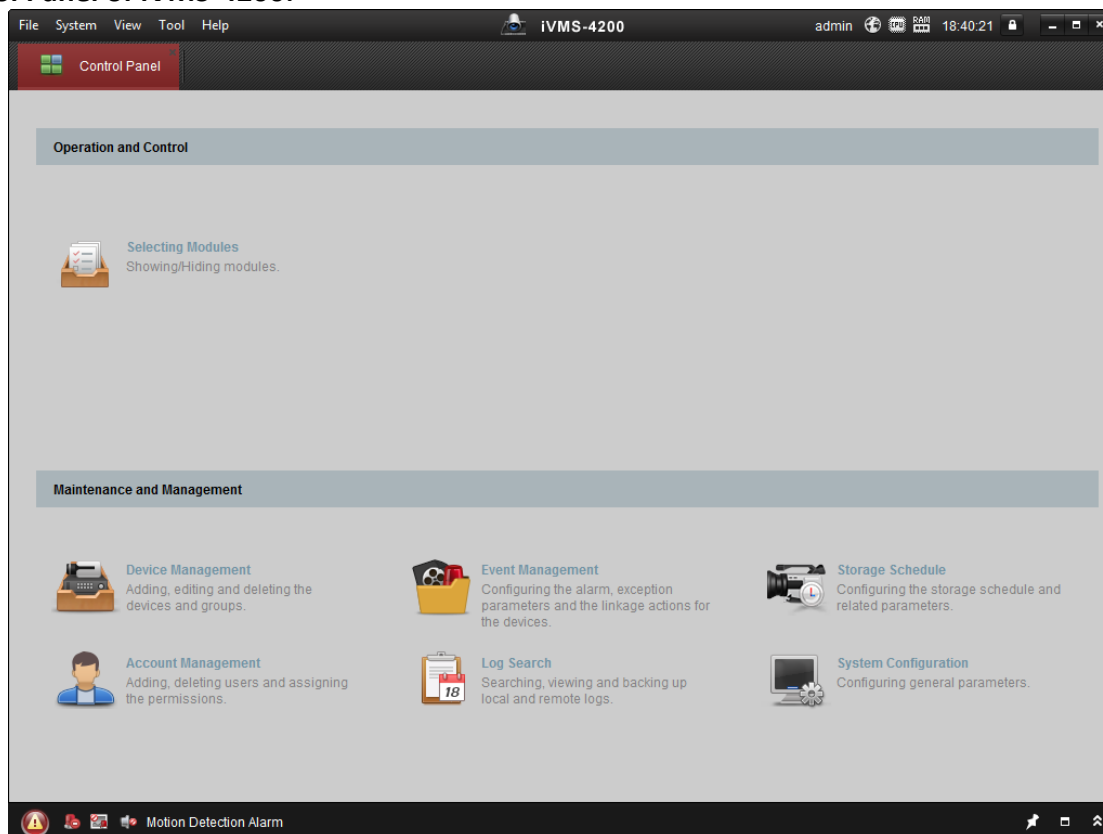

7.2 User Registration and Login

For the first time to use iVMS-4200 client software, you need to register a super user for login.

Steps:

1. Input the super user name and password. The software will judge password strength automatically, and we highly recommend you to use a strong password to ensure your data security.
2. Confirm the password.
3. Optionally, check the checkbox **Enable Auto-login** to log into the software automatically.
4. Click **Register**. Then, you can log into the software as the super user.

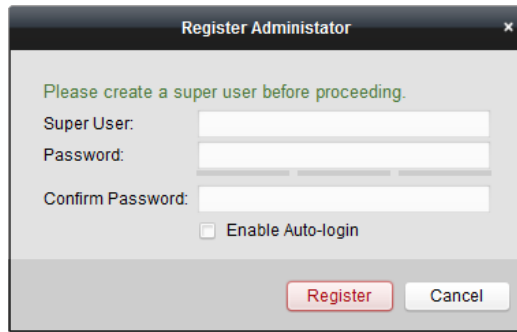

- ◆ A user name cannot contain any of the following characters: / \ : * ? " < > |. And the length of the password cannot be less than 6 characters.
- ◆ For your privacy, we strongly recommend changing the password to something of your own choosing (using a minimum of 8 characters, including upper case letters, lower case letters, numbers, and special characters) in order to increase the security of your product.
- ◆ Proper configuration of all passwords and other security settings is the responsibility of the installer and/or end-user.

When opening iVMS-4200 after registration, you can log into the client software with the registered user name and password.

Steps:

1. Input the user name and password you registered.

Note: If you forget your password, please click **Forgot Password** and remember the encrypted string in the pop-up window. Contact your dealer and send the encrypted string to him to reset your password.

2. Optionally, check the checkbox **Enable Auto-login** to log into the software automatically.
3. Click **Login**.

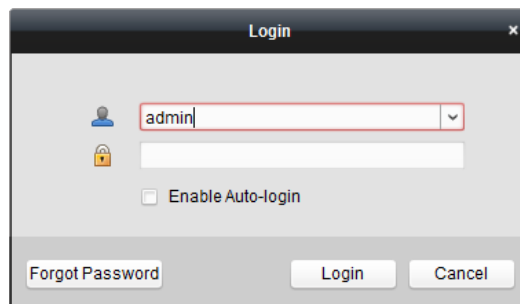

After running the client software, you can open the wizards (including video wizard, video wall wizard, security control panel wizard, access control and video intercom wizard, and attendance wizard), to guide you to add the device and do other settings and operations. For detailed configuration about the wizards, please refer to the *Quick Start Guide of iVMS-4200*.

7.3 System Configuration

Purpose:

You can synchronize the missed access control events to the client.

Steps:

1. Click **Tool – System Configuration**.
2. In the System Configuration window, check the **Auto-synchronize Access Control Event** checkbox.
3. Set the synchronization time.
The client will auto-synchronize the missed access control event to the client at the set time.

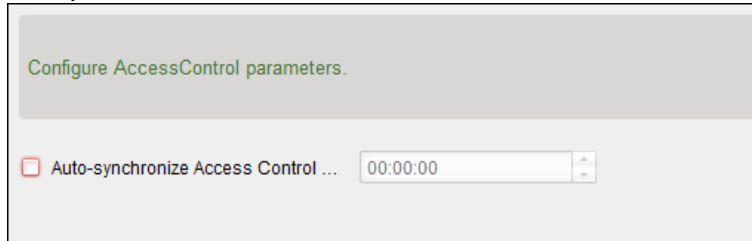

7.4 Access Control Management

Purpose:

The Access Control module is applicable to access control devices and video intercom. It provides multiple functionalities, including person and card management, permission configuration, access control status management, video intercom, and other advanced functions.

You can also set the event configuration for access control and display access control points and zones on E-map.

Note: For the user with access control module permissions, the user can enter the Access Control module and configure the access control settings.



Click  in the control panel, and check **Access Control** to add the Access Control module to the control panel.



Click  to enter the Access Control module.

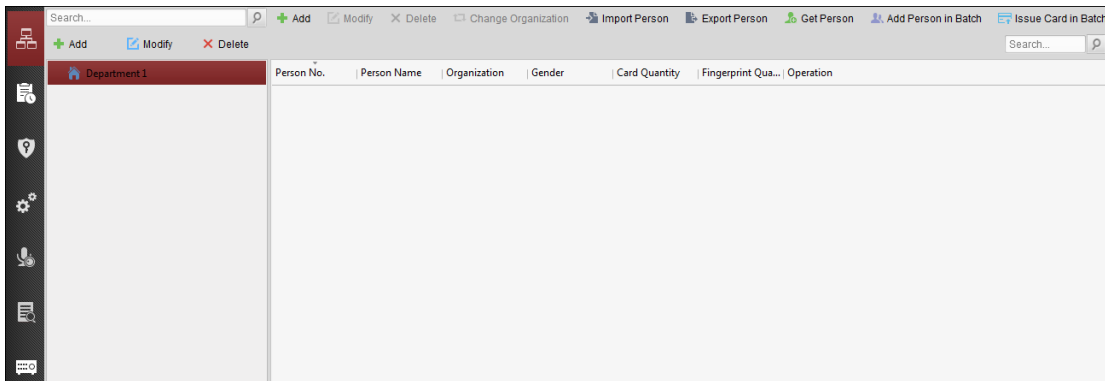

Before you start:

For the first time opening the Access Control module, the following dialog will pop up and you are required to select the scene according to the actual needs.

You can select the scene as **Non-residence** and **Residence**.

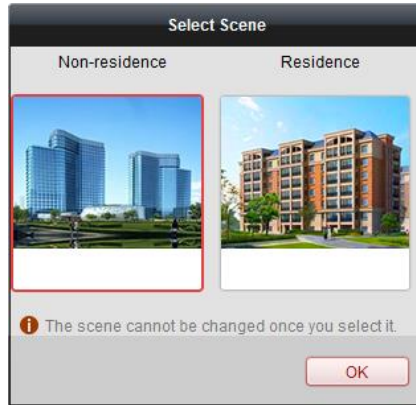

Notes:

- Once the scene is configured, you cannot change it later.
- When you select **Non-Residence** mode, you cannot configure the Attendance Rule when adding person.

The Access Control module is composed of the following sub modules.

	Person and Card	Managing the organizations, persons, and assigning cards to persons.
	Schedule and Template	Configuring the week schedule, holiday group, and setting the template.
	Permission	Assigning access control permissions to persons and applying to the devices.
	Advanced Function	Providing advanced functions including access control parameters settings, card reader authentication, opening door with first card, anti-passing back, multi-door interlocking, and authentication password.
	Video Intercom	Video intercom between client and resident, searching the dial log, and releasing notice.
	Search	Searching history events of access control; Searching call logs, unlocking logs, and released notices.
	Device Management	Managing the access control devices and video intercom devices.

Note: In this chapter, we only introduce the operations about access control.

7.4.1 Adding Access Control Device

Click in the Access Control module to enter the following interface.

Device Type	Nickname	Connection ...	Network Parameters	Device Serial No.
Access Controller	Access Controller	TCP/IP	10.18.146.86:8000	DS- [REDACTED] 6
Encoding Device	10.33.3.159	TCP/IP	10.33.3.159:8000	DS- [REDACTED] 3
Encoding Device	10.16.6.250	TCP/IP	10.16.6.250:8000	2014- [REDACTED]
Encoding Device	10.20.132.215	TCP/IP	10.20.132.215:8000	DS- [REDACTED] 7
Encoding Device	10.66.76.193	TCP/IP	10.66.76.193:8005	DS- [REDACTED] J
Indoor Station	Indoor Station	TCP/IP	10.16.6.104:8000	DS- [REDACTED] J
Security Control Panel	Security Control Pa...	TCP/IP	10.18.146.81:8000	DS- [REDACTED] U
Security Control Panel	10.16.6.92	TCP/IP	10.16.6.92:8000	DS- [REDACTED] 7

Note: After adding the device, you should check the device arming status in **Tool – Device Arming Control**. If the device is not armed, you should arm it, or you will not receive the events via the client software. For details about device arming control, refer *7.12 Arming Control*.

Creating Password

Purpose:

For some devices, you are required to create the password to activate them before they can be added to the software and work properly.

Note: This function should be supported by the device.

Steps:

1. Enter the Device Management page.
2. On the **Device for Management** or **Online Device** area, check the device status (shown on **Security** column) and select an inactive device.

IP	Device Type	Firmware Version	Security	Server Port	Device Serial No.	Start Time
192.0.0.64	[REDACTED]	[REDACTED]	Active	8000	[REDACTED]	2017-01
192.168.1.64	[REDACTED]	[REDACTED]	Inactive	8000	[REDACTED]	2017-01

3. Click the **Activate** button to pop up the Activation interface.
4. Create a password in the password field, and confirm the password.



STRONG PASSWORD RECOMMENDED– We highly recommend you create a strong password of your own choosing (using a minimum of 8 characters, including upper case letters, lower case letters, numbers, and special characters) in order to increase the security of your product. And we recommend you reset your password regularly, especially in the high security system,

resetting the password monthly or weekly can better protect your product.

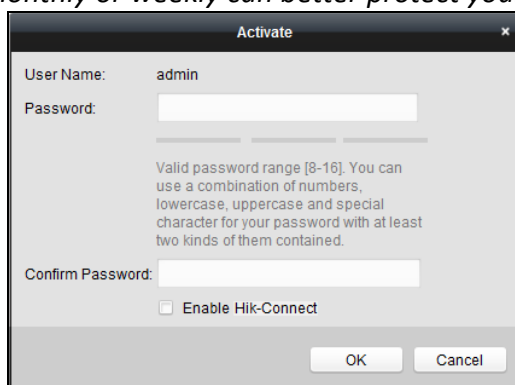

5. (Optional) Enable Hik-Connect service when activating the device if the device supports.

1) Check **Enable Hik-Connect** checkbox to pop up the Note dialog.

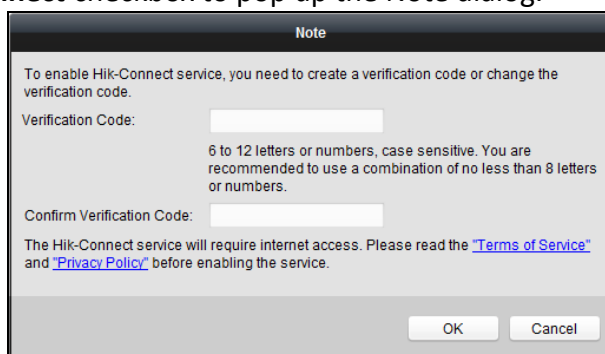

2) Create a verification code.

3) Confirm the verification code.

4) Click **Terms of Service** and **Privacy Policy** to read the requirements.

5) Click **OK** to enable the Hik-Connect service.

6. Click **OK** to activate the device.

A "The device is activated." window pops up when the password is set successfully.

7. Click **Modify Netinfo** to pop up the Modify Network Parameter interface.

Note: This function is only available on the **Online Device** area. You can change the device IP address to the same subnet with your computer if you need to add the device to the software.

8. Change the device IP address to the same subnet with your computer by either modifying the IP address manually or checking the checkbox of DHCP.

9. Input the password set in step 4 and click **OK** to complete the network settings.

Adding Online Device

Purpose:

The active online devices in the same local subnet with the client software will be displayed on the **Online Device** area. You can click the **Refresh Every 60s** button to refresh the information of the online devices.

Note: You can click  to hide the **Online Device** area.

IP	Device Type	Firmware Version	Security	Server Port	Device Serial No.	Start Time
10.16.6.236	D		Active	8000		2017-01
10.16.6.92	D		Active	8000		2017-01
192.0.0.64	D		Active	8000		2017-01

Steps:

1. Select the devices to be added from the list.

Note: For the inactive device, you need to create the password for it before you can add the device properly. For detailed steps, please refer to *Chapter 6 Activating the Access Control Terminal*.

2. Click **Add to Client** to open the device adding dialog box.

3. Input the required information.

Nickname: Edit a name for the device as you want.

Address: Input the device's IP address. The IP address of the device is obtained automatically in this adding mode.

Port: Input the device port No. The default value is *8000*.

User Name: Input the device user name. By default, the user name is *admin*.

Password: Input the device password.



The password strength of the device can be checked by the software. For your privacy, we strongly recommend changing the password to something of your own choosing (using a

minimum of 8 characters, including upper case letters, lower case letters, numbers, and special characters) in order to increase the security of your product. And we recommend you reset your password regularly, especially in the high security system, resetting the password monthly or weekly can better protect your product.

4. Optionally, check the **Export to Group** checkbox to create a group by the device name. You can import all the channels of the device to the corresponding group by default.

Note: iVMS-4200 also provides a method to add the offline devices.

- 1) Check the **Add Offline Device** checkbox.
- 2) Input the required information, including the device channel number and alarm input number.
- 3) Click **Add**.

When the offline device comes online, the software will connect it automatically.

5. Click **Add** to add the device.

➤ Adding Multiple Online Device

If you want to add multiple online devices to the client software, click and hold *Ctrl* key to select multiple devices, and click **Add to Client** to open the device adding dialog box. In the pop-up message box, enter the user name and password for the devices to be added.

➤ Adding All Online Devices

If you want to add all the online devices to the client software, click **Add All** and click **OK** in the pop-up message box. Then enter the user name and password for the devices to be added.

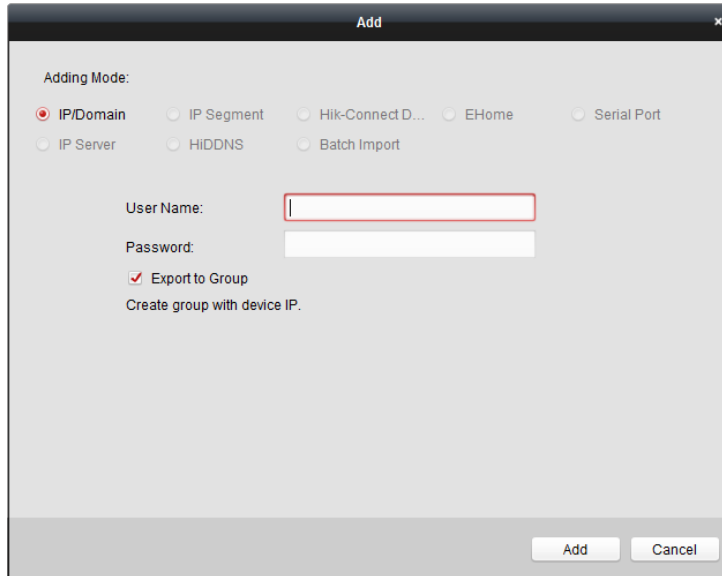

Adding Devices by IP or Domain Name

Steps:

1. Click **Add** to open the device adding dialog box.
2. Select **IP/Domain** as the adding mode.
3. Input the required information.

Nickname: Edit a name for the device as you want.

Address: Input the device's IP address or domain name.

Port: Input the device port No.. The default value is *8000*.

User Name: Input the device user name. By default, the user name is *admin*.

Password: Input the device password.



The password strength of the device can be checked by the software. For your privacy, we strongly recommend changing the password to something of your own choosing (using a minimum of 8 characters, including upper case letters, lower case letters, numbers, and special characters) in order to increase the security of your product. And we recommend you reset your password regularly, especially in the high security system, resetting the password monthly or weekly can better protect your product.

4. Optionally, check the **Export to Group** checkbox to create a group by the device name. You can import all the channels of the device to the corresponding group by default.

Note: iVMS-4200 also provides a method to add the offline devices.

- 1) Check the **Add Offline Device** checkbox.
- 2) Input the required information, including the device channel number and alarm input number.
- 3) Click **Add**.

When the offline device comes online, the software will connect it automatically.

5. Click **Add** to add the device.

Adding Devices by IP Segment

Steps:

1. Click **Add** to open the device adding dialog box.
2. Select **IP Segment** as the adding mode.
3. Input the required information.

Start IP: Input a start IP address.

End IP: Input an end IP address in the same network segment with the start IP.

Port: Input the device port No.. The default value is *8000*.

User Name: Input the device user name. By default, the user name is *admin*.

Password: Input the device password.



The password strength of the device can be checked by the software. For your privacy, we strongly recommend changing the password to something of your own choosing (using a minimum of 8 characters, including upper case letters, lower case letters, numbers, and special characters) in order to increase the security of your product. And we recommend you reset your password regularly, especially in the high security system, resetting the password monthly or weekly can better protect your product.

4. Optionally, check the **Export to Group** checkbox to create a group by the device name. You can import all the channels of the device to the corresponding group by default.

Note: iVMS-4200 also provides a method to add the offline devices.

- 1) Check the **Add Offline Device** checkbox.
- 2) Input the required information, including the device channel number and alarm input number.
- 3) Click **Add**.

When the offline device comes online, the software will connect it automatically.

5. Click **Add**.

You can add the device which the IP address is between the start IP and end IP to the device

list.

Importing Devices in Batch

Purpose:

The devices can be added to the software in batch by inputting the device information in the pre-defined CSV file.

Steps:

1. Click **Add** to open the device adding dialog box.
2. Select **Batch Import** as the adding mode.

3. Click **Export Template** and save the pre-defined template (CSV file) on your PC.
4. Open the exported template file and input the required information of the devices to be added on the corresponding column.

Nickname: Edit a name for the device as you want.

Adding Mode: You can input 0, 2, 3, 4, 5, or 6 which indicated different adding modes. 0 indicates that the device is added by IP address or domain name; 2 indicates that the device is

added via IP server; 3 indicates that the device is added via HiDDNS; 4 indicates that the device is added via EHome protocol; 5 indicates that the device is added by serial port; 6 indicates that the device is added via Hik-Connect Domain.

Address: Edit the address of the device. If you set 0 as the adding mode, you should input the IP address or domain name of the device; if you set 2 as the adding mode, you should input the IP address of the PC that installs the IP Server; if you set 3 as the adding mode, you should input *www.hik-online.com*.

Port: Input the device port No.. The default value is 8000.

Device Information: If you set 0 as the adding mode, this field is not required; if you set 2 as the adding mode, input the device ID registered on the IP Server; if you set 3 as the adding mode, input the device domain name registered on HiDDNS server; if you set 4 as the adding mode, input the EHome account; if you set 6 as the adding mode, input the device serial No.

User Name: Input the device user name. By default, the user name is *admin*.

Password: Input the device password.



The password strength of the device can be checked by the software. For your privacy, we strongly recommend changing the password to something of your own choosing (using a minimum of 8 characters, including upper case letters, lower case letters, numbers, and special characters) in order to increase the security of your product. And we recommend you reset your password regularly, especially in the high security system, resetting the password monthly or weekly can better protect your product.

Add Offline Device: You can input 1 to enable adding the offline device, and then the software will automatically connect it when the offline device comes online. 0 indicates disabling this function.

Export to Group: You can input 1 to create a group by the device name (nickname). All the channels of the device will be imported to the corresponding group by default. 0 indicates disabling this function.

Channel Number: If you set 1 for Add Offline Device, input the channel number of the device. If you set 0 for Add Offline Device, this field is not required.

Alarm Input Number: If you set 1 for Add Offline Device, input the alarm input number of the device. If you set 0 for Add Offline Device, this field is not required.

Serial Port No.: If you set 5 as the adding mode, input the serial port No. for the access control device.

Baud Rate: If you set 5 as the adding mode, input the baud rate of the access control device.

DIP: If you set 5 as the adding mode, input the DIP address of the access control device.

Hik-Connect Account: If you set 6 as the adding mode, input the Hik-Connect account.

Hik-Connect Password: If you set 6 as the adding mode, input the Hik-Connect password.

5. Click  and select the template file.

6. Click **Add** to import the devices.

The devices will be displayed on the device list for management after added successfully. You can check the resource usage, HDD status, recording status, and other information of the added devices on the list.

Click **Refresh All** to refresh the information of all added devices. You can also input the device name in the filter field for search.

7.4.2 Viewing Device Status

In the device list, you can select the device and then click **Device Status** button to view its status.

Note: The interface may differ from the picture displayed above. Refer to the actual interface when adopting this function.

Door Status: The status of the connected door.

Host Status: The status of the host, including Storage Battery Power Voltage, Device Power Supply Status, Multi-door Interlocking Status, Anti-passing Back Status, and Host Anti-Tamper Status.

Card Reader Status: The status of card reader.

Note: If you use the card reader with RS-485 connection, you can view the status of online or offline. If you use the card reader with Wiegand connection, you can view the status of offline.

Alarm Output Status: The alarm output status of each port.

Event Sensor Status: The event sensor status of each port.

Arming Status: The status of the device.

7.4.3 Editing Basic Information

Purpose:

After adding the access control device, you can edit the device basic information.

Steps:

1. Select the device in the device list.
2. Click **Modify** to pop up the modifying device information window.
3. Click **Basic Information** tab to enter the Basic Information interface.

Adding Mode:

IP/Domain
 IP Segment
 Hik-Connect D...
 EHome
 Serial Port
 IP Server
 HiDDNS
 Batch Import

Nickname:

Address:

Port:

User Name:

Password:



4. Edit the device information, including the adding mode, the device name, the device IP address, port No., user name, and the password.

7.4.4 Remote Configuration

Purpose:

In the device list, select the device and click **Remote Configuration** button to enter the remote configuration interface. You can set the detailed parameters of the selected device.

Checking Device Information

Steps:

1. In the device list, you can click **Remote Configuration** to enter the remote configuration interface.
2. Click **System** -> **Device Information** to check the device basic information and the device version information.

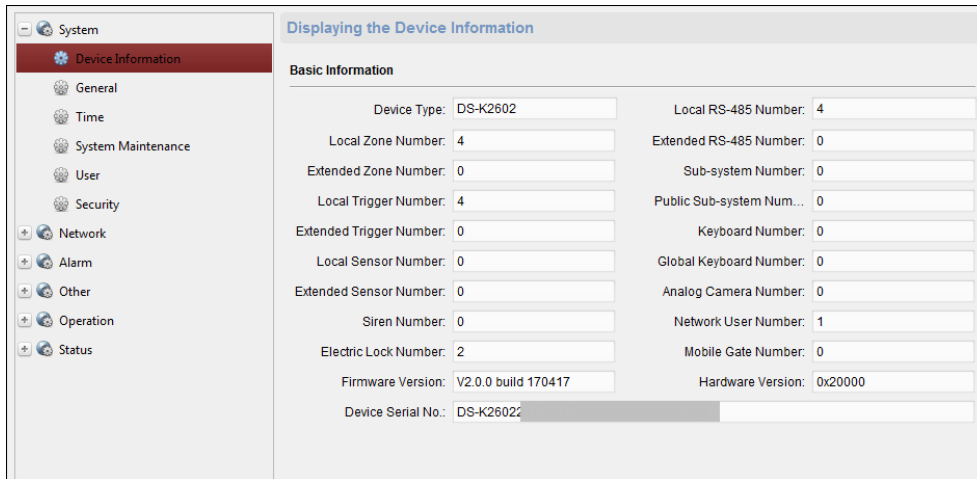

Editing Device Name

In the Remote Configuration interface, click **System** -> **General** to configure the device name. Click **Save** to save the settings.

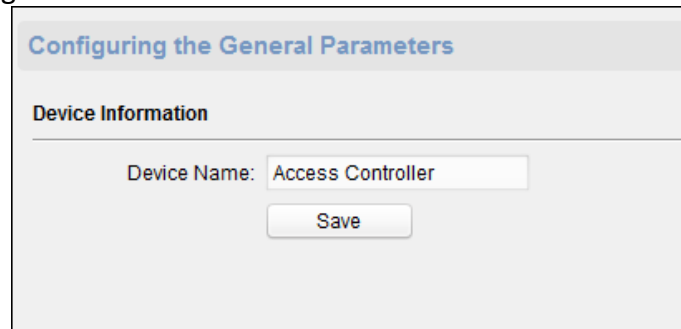

Editing Time

Steps:

1. In the Remote Configuration interface, click **System** -> **Time** to configure the time zone.
2. (Optional) Check **Enable NTP** and configure the NTP server address (or server domain), the NTP port, and the synchronization interval.
3. (Optional) Check **Enable DST** and configure the DST star time, end time and the bias.
4. Click **Save** to save the settings.

Configuring the Time Settings (e.g., NTP, DST)

Time Zone

Select Time Zone: (GMT+08:00) Beijing, Hong Kong, Perth, Singa... ▾

Enable NTP

Server Address:

NTP Port:

Sync Interval: Minute(s)

Enable DST

Start Time: April ▾ First Week ▾ Sun ▾ 2 :00

End Time: October ▾ Last Week ▾ Sun ▾ 2 :00

DST Bias: 60 min ▾

Setting System Maintenance

Steps:

1. In the Remote Configuration interface, click **System** -> **System Maintenance**.
2. Click **Reboot** to reboot the device.
 Or click **Restore Default Settings** to restore the device settings to the default ones, excluding the IP address.
 Or click **Restore All** to restore the device parameters to the default ones. The device should be activated after restoring.
Note: The configuration file contains the device parameters.
3. You can also remote upgrade the device.
 - 1) In the Remote Upgrade part, select an upgrade file type in the dropdown list.
 You can select Controller Upgrade File or Card Reader Upgrade in the drop-down list.
 - 2) Click to select the upgrade file.
 - 3) Click **Upgrade** to start upgrading.
Note: Only card readers connected via RS-485 can be upgraded. DS-K2800 series access controller only supports Wiegand card reader.

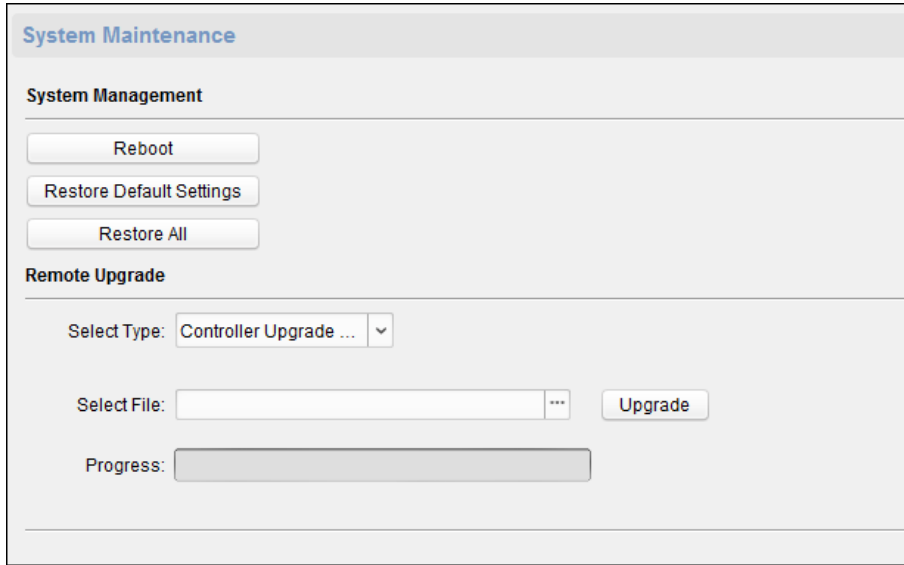

Managing User

Steps:

1. In the Remote Configuration interface, click **System -> User**.

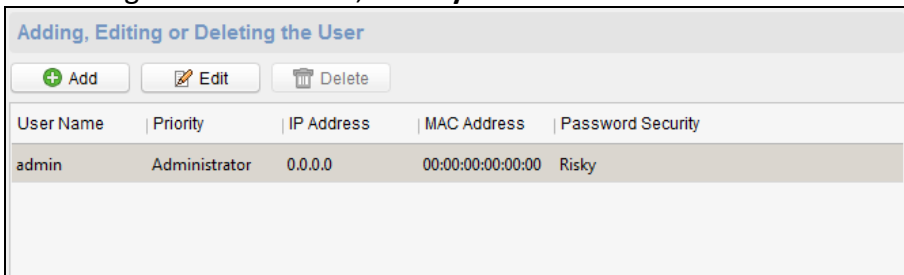

2. Click **Add** to add the user.

Or select a user in the user list and click **Edit** to edit the user. You are able to edit the user password, the IP address, the MAC address and the user permission. Click **OK** to confirm editing.

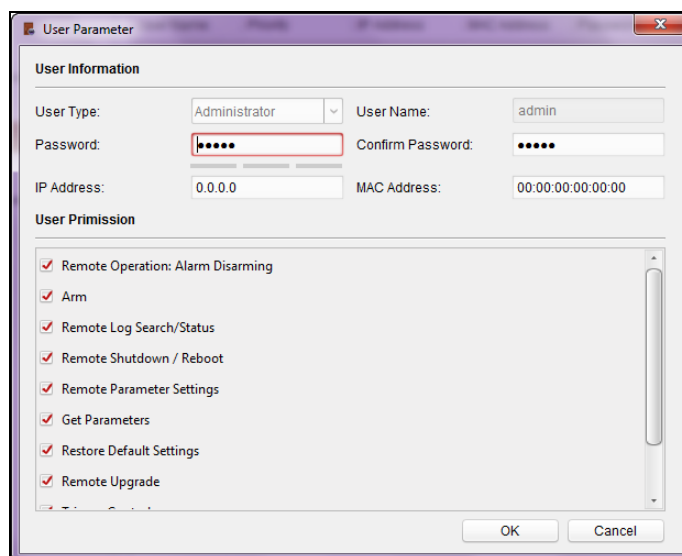

Setting Security

Steps:

1. Click **System** -> **Security**.

The screenshot shows a dialog box titled "Configuring the Security Parameters". Under the "Encryption Mode" section, there is a dropdown menu labeled "Level:" with "Compatible Mode" selected. A "Save" button is located at the bottom right of the dialog.

2. Select the encryption mode in the dropdown list.
You can select Compatible Mode or Encryption Mode.
3. Click **Save** to save the settings.

Configuring Network Parameters

Click **Network** -> **General**. You can configure the NIC type, the IPv4 address, the subnet mask (IPv4), the default gateway (IPv4), MTU address, MTU, and the device port. Click **Save** to save the settings.

The screenshot shows a dialog box titled "Configuring the Network Parameters". It contains several input fields: "NIC Type" (dropdown menu), "IPv4 Address", "Subnet Mask (IPv4)", "Default Gateway (IPv4)", "MAC Address", "MTU(Byte)" (set to 1500), and "Device Port" (set to 8000). A "Save" button is located at the bottom right.

Configuring Advanced Network





Click **Network** -> **Advanced Settings**. You can configure the DNS address 1, the DNS address 2, the alarm host IP and the alarm host port. Click **Save** to save the settings.

The screenshot shows a dialog box titled "Configuring the Advanced Network Settings". It contains four input fields: "DNS1 IP Address" (0.0.0.0), "DNS2 IP Address" (0.0.0.0), "Security Control Platform..." (0.0.0.0), and "Security Control Platform..." (0). A "Save" button is located at the bottom center.

Configuring Relay Parameters

Steps:

1. Click **Alarm** -> **Relay**.
You can view the relay parameters.

Configuring Relay Parameters				
Relay	Name	Output Delay(s)	Zone Linkage	Settings
1		0	None	
2		0	None	
3		0	None	
4		0	None	

2. Click the  to pop up the Relay Parameters Settings window.
3. Set the relay name and the output delay.
4. Click **Save** to save the paramters.
Or click **Copy to...** to copy the relay information to other relays.

Configuring Access Control Parameters

Steps:

1. In the Remote Configuration interface, click **Other** -> **Access Control Parameters**.
2. Select and check the **Press Key to Input Card No.** checkbox.
3. Click **Save** to save the settings.

Configuring Face Detection Parameters

Click **Other** -> **Face Detection**. You can check the **Enable** checkbox to enable the device face detection function.

Note: Only devices with video function support this function.

Configuring the Face Detection Parameters

Enable

Operating Relay

Steps:

1. Click **Operation** -> **Relay**.
You can view the relay status.
2. Check the relay checkbox
3. Click **Open** or **Close** to open/close the relay.
4. (Optional) Click **Refresh** to refresh the relay status.

Relay Operation		
<input type="button" value="Open"/>		<input type="button" value="Close"/>
		<input type="button" value="Refresh"/>
<input type="checkbox"/> Relay No.	Name	Status
<input type="checkbox"/> 1		Close
<input type="checkbox"/> 2		Close
<input type="checkbox"/> 3		Close
<input type="checkbox"/> 4		Close

Viewing Relay Status

Click **Status** -> **Relay** to view the relay status.

Relay Status	
Relay	Status
Relay1	Close
Relay2	Close
Relay3	Close
Relay4	Close

7.5 Person and Card Management

You can add, edit, and delete the organization and person in Person and Card Management module.

Click  tab to enter the Person and Card Management interface.

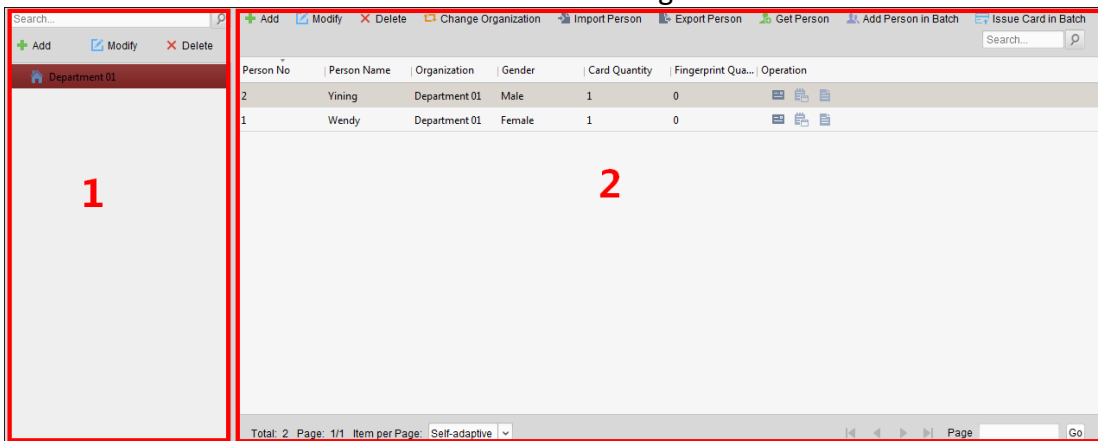

The interface

is divided into two parts: Organization Management and Person Management.

1	Organization Management	You can add, edit, or delete the organization as desired.
2	Person Management	After adding the organization, you can add the person to the organization and issue card to persons for further management.

7.5.1 Organization Management

Adding Organization

Steps:

1. In the organization list on the left, you should add a top organization as the parent organization of all organizations.
Click **Add** button to pop up the adding organization interface.

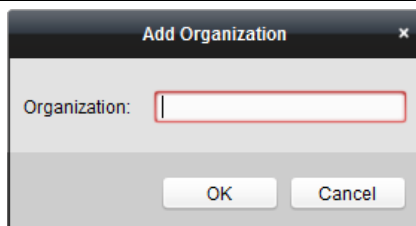

2. Input the Organization Name as desired.
3. Click **OK** to save the adding.
4. You can add multiple levels of organizations according to the actual needs.
To add sub organizations, select the parent organization and click **Add**.
Repeat *Step 2* and *3* to add the sub organization.
Then the added organization will be the sub-organization of the upper-level organization.

Note: Up to 10 levels of organizations can be created.

Modifying and Deleting Organization

You can select the added organization and click **Modify** to modify its name.

You can select an organization, and click **Delete** button to delete it.

Notes:

- The lower-level organizations will be deleted as well if you delete an organization.
- Make sure there is no person added under the organization, or the organization cannot be deleted.

7.5.2 Person Management

After adding the organization, you can add person to the organization and manage the added person such as issuing cards in batch, importing and exporting persons information in batch, etc.

Note: Up to 10,000 persons or cards can be added.

Adding Person

Adding Person (Basic Information)

Steps:

1. Select an organization in the organization list and click **Add** button on the Person panel to pop up the adding person dialog.

2. The Person No. will be generated automatically and is not editable.
3. Input the basic information including person name, gender, phone No., birthday details, and email address.
4. Click **Upload Picture** to select the person picture from the local PC to upload it to the client.
Note: The picture should be in *.jpg format.
5. (Optional) You can also click **Take Photo** to take the person's photo with the PC camera.
6. Click **OK** to finish adding.

Adding Person (Detailed Information)

Steps:

1. In the Add Person interface, click **Details** tab.

2. Input the detailed information of the person, including person's ID type, ID No., country, etc., according to actual needs.
 - **Linked Device:** You can bind the indoor station to the person.
Note: If you select **Analog Indoor Station** in the Linked Device, the **Door Station** field will display and you are required to select the door station to communicate with the analog

indoor station.

- **Room No.:** You can input the room No. of the person.

3. Click **OK** to save the settings.

Adding Person (Permission)

You can assign the permissions (including operation permissions of access control device and access control permissions) to the person when adding person.

Note: For setting the access control permission, refer to *Chapter 7.7 Permission Configuration*.

Steps:

1. In the Add Person interface, click **Permission** tab.

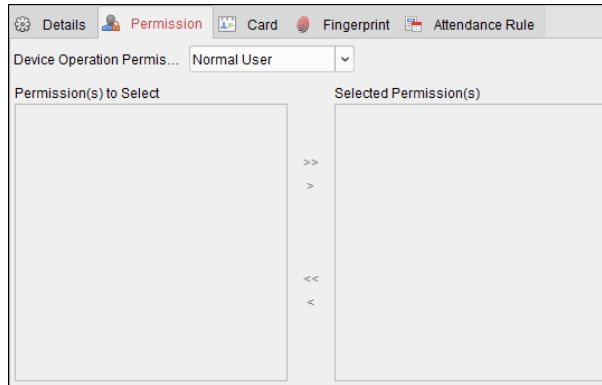

2. In the Device Operation Role field, select the role of operating the access control device.

Normal User: The person has the permission to check-in/out on the device, pass the access control point, etc.

Administrator: The person has the normal user permission, as well as permission to configure the device, including adding normal user, etc.

3. In the Permission(s) to Select list, all the configured permissions display.

Check the permission(s) checkbox(es) and click > to add to the Selected Permission(s) list.

(Optional) You can click >> to add all the displayed permissions to the Selected Permission(s) list.

(Optional) In the Selected Permission(s) list, select the selected permission and click < to remove it. You can also click << to remove all the selected permissions.

4. Click **OK** to save the settings.

Adding Person (Card)

You can add card and issue the card to the person.

Steps:

1. In the Add Person interface, click **Card** tab.

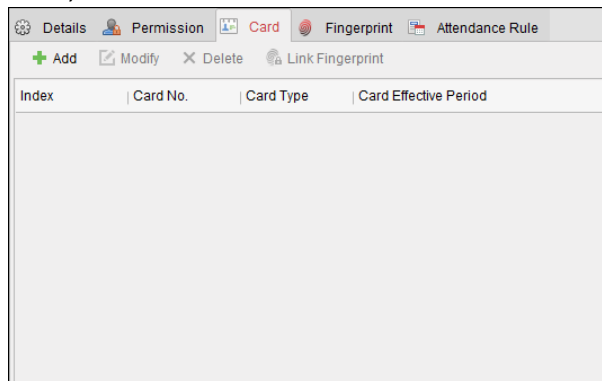

2. Click **Add** to pop up the Add Card dialog.

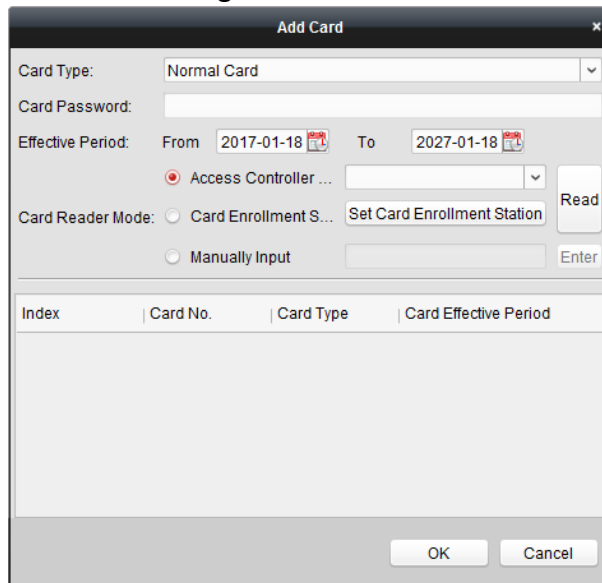

3. Select the card type according to actual needs.

- **Normal Card**
- **Card for Door Extended Opening:** The door will remain open for the configured time period for the card holder.
- **Card in Blocklist:** The card swiping action will be uploaded and the door cannot be opened.
- **Patrol Card:** The card swiping action can be used for checking the working status of the inspection staff. The access permission of the inspection staff is configurable.
- **Duress Card:** The door can open by swiping the duress card when there is duress. At the same time, the client can report the duress event.
- **Super Card:** The card is valid for all the doors of the controller during the configured schedule.
- **Visitor Card:** The card is assigned for visitors. For the Visitor Card, you can set the **Max. Swipe Times**.

Notes:

- The Max. Swipe Times should be between 0 and 255. When your swiping card times is more than the configured times, card swiping will be invalid.
- When set the times as 0, it means the card swiping is unlimited.

4. Input the password of the card itself in the Card Password field. The card password should contain 4 to 8 digits.

Note: The password will be required when the card holder swiping the card to get enter to or exit from the door if you enable the card reader authentication mode as **Card and Password**, **Password and Fingerprint**, and **Card, Password, and Fingerprint**. For details, *Chapter 7.8.2 Card Reader Authentication*.

5. Click  to set the effective time and expiry time of the card.

6. Select the Card Reader Mode for reading the card No.

- **Access Controller Reader:** Place the card on the reader of the Access Controller and click **Read** to get the card No.

- **Card Enrollment Station:** Place the card on the Card Enrollment Station and click **Read** to get the card No.

Note: The Card Enrollment Station should connect with the PC running the client. You can click **Set Card Enrollment Station** to enter the following dialog.

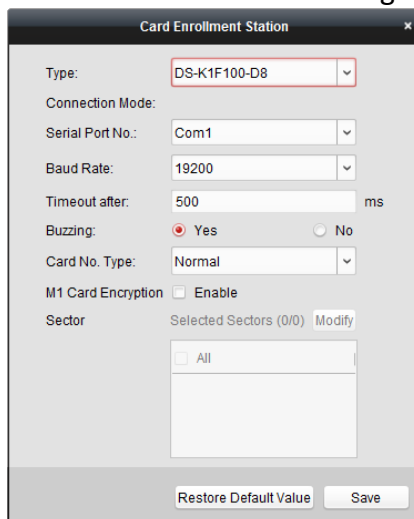

- 2) Select the Card Enrollment Station type.

Note: Currently, the supported card reader types include DS-K1F100-D8, DS-K1F100-M, DS-K1F100-D8E, and DS-K1F180-D8E.

- 3) Set the serial port No., the baud rate, the timeout value, the buzzing, or the card No. type.

Note: DS-K2800 series access controller does not support the M1 card encryption function.

- 4) Click **Save** button to save the settings.

You can click **Restore Default Value** button to restore the defaults.

- **Manually Input:** Input the card No. and click **Enter** to input the card No.

7. Click **OK** and the card(s) will be issued to the person.

8. (Optional) You can select the added card and click **Edit** or **Delete** to edit or delete the card.

9. Click **OK** to save the settings.

Adding Person (Attendance Rule)

You can set the attendance rule for the person.

Note: This tab page will display when you select **Non-Residence** mode in the application scene when running the software for the first time.

Steps:

1. In the Add Person interface, click **Attendance Rule** tab.

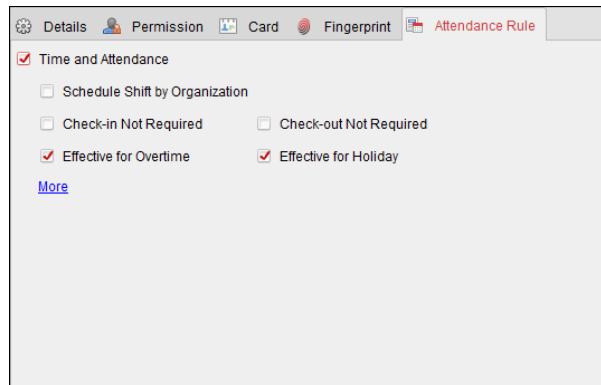

2. If the person joins in the time and attendance, check the **Time and Attendance** checkbox to enable this function for the person. Then the person's card swiping records will be recorded and analyzed for time and attendance.
For details about Time and Attendance, click **More** to go to the Time and Attendance module.
3. Click **OK** to save the settings.

Importing and Exporting Person Information

The person information can be imported and exported in batch.

Steps:

1. **Exporting Person:** You can export the added persons' information in Excel format to the local PC.
 - 1) After adding the person, you can click **Export Person** button in the Person and Card tab to pop up the following dialog.
 - 2) Click  to select the path of saving the exported Excel file.
 - 3) Check the checkboxes to select the person information to export.

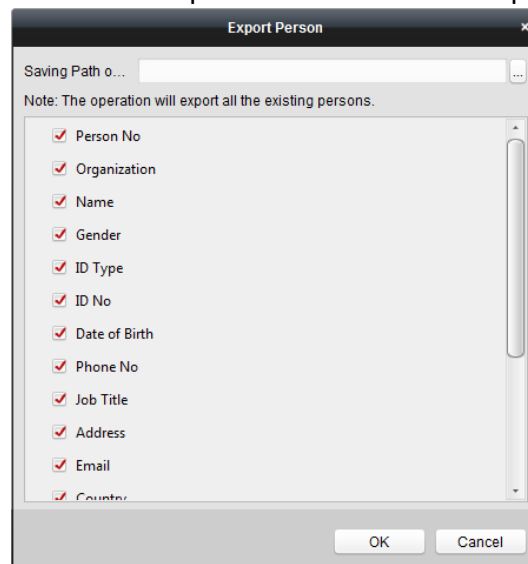

- 4) Click **OK** to start exporting.
2. **Importing Person:** You can import the Excel file with persons information in batch from the local PC
 - 1) click **Import Person** button in the Person and Card tab.

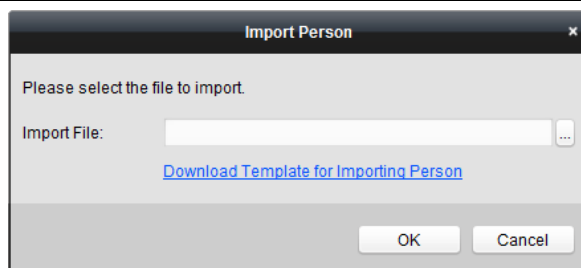

- 2) You can click **Download Template for Importing Person** to download the template first.
- 3) Input the person information to the downloaded template.
- 4) Click to select the Excel file with person information.
- 5) Click **OK** to start importing.

Getting Person Information from Access Control Device

If the added access control device has been configured with person information (including person details, fingerprint, issued card information), you can get the person information from the device and import to the client for further operation.

Note: This function is only supported by the device the connection method of which is TCP/IP when adding the device.

Steps:

1. In the organization list on the left, click to select an organization to import the persons.
2. Click **Get Person** button to pop up the following dialog box.

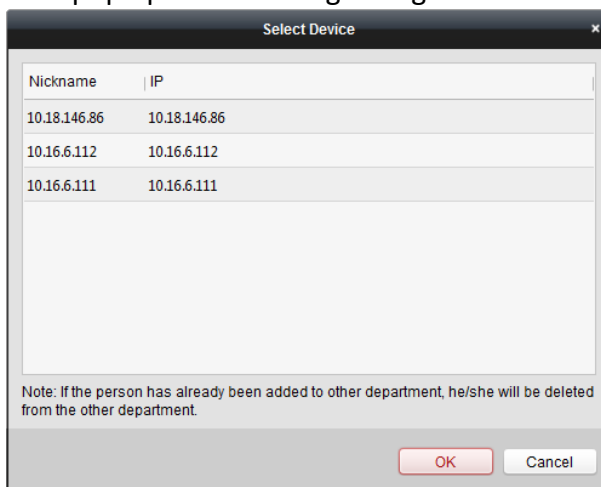

3. The added access control device will be displayed.
4. Click to select the device and then click **OK** to start getting the person information from the device.



You can also double click the device name to start getting the person information.

Notes:

- The person information, including person details, person’s fingerprint information (if configured), and the linked card (if configured), will be imported to the selected organization.
- If the person name stored in the device is empty, the person name will be filled with the issued card No. after importing to the client.
- The gender of the persons will be **Male** by default.
- Up to 10000 persons with up to 5 cards each can be imported.

Managing Person

Modifying and Deleting Person

To modify the person information and attendance rule, click  or  in the Operation column, or select the person and click **Modify** to open the editing person dialog.

You can click  to view the person's card swiping records.

To delete the person, select a person and click **Delete** to delete it.

Note: If a card is issued to the current person, the linkage will be invalid after the person is deleted.

Changing Person to Other Organization

You can move the person to another organization if needed.

Steps:

1. Select the person in the list and click **Change Organization** button.

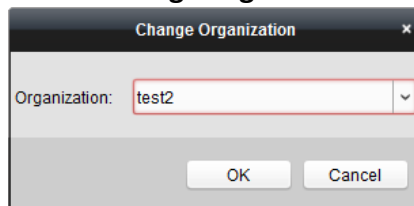

2. Select the organization to move the person to.
3. Click **OK** to save the settings.

Issuing Card in Batch

You can issue multiple cards for the person with no card issued in batch.

Steps:

1. Click **Issue Card in Batch** button to enter the following dialog.

All the added person with no card issued will display in the Person(s) with No Card Issued list.

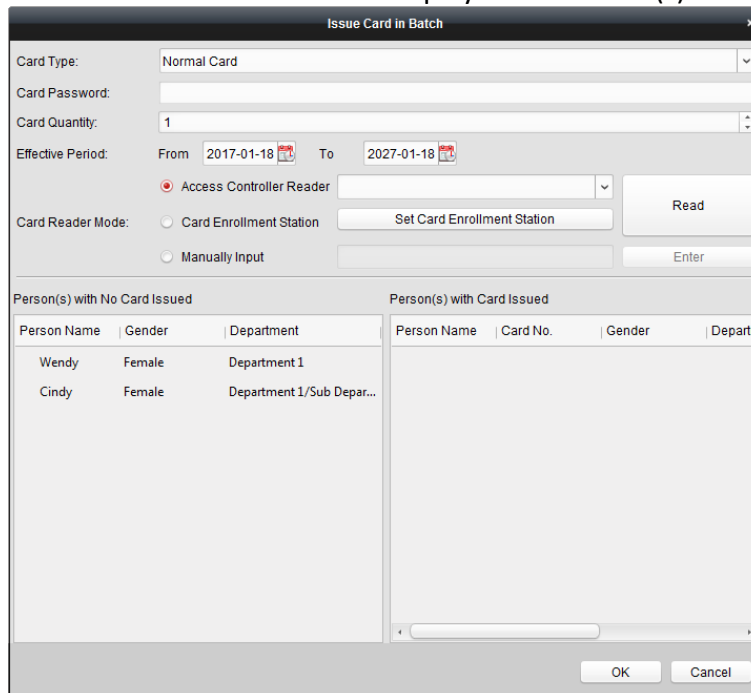

2. Select the card type according to actual needs.

Note: For details about the card type, refer to *Adding Person*.

- Input the password of the card itself in the Card Password field. The card password should contain 4 to 8 digits.

Note: The password will be required when the card holder swiping the card to get enter to or exit from the door if you enable the card reader authentication mode as **Card and Password**, **Password and Fingerprint**, and **Card, Password, and Fingerprint**. For details, refer to *Chapter 7.8.2 Card Reader Authentication*.

- Input the card quantity issued for each person.
For example, if the Card Quantity is 3, you can read or enter three card No. for each person.
- Click  to set the effective time and expiry time of the card.
- Select the Card Reader Mode for reading the card No.
 - **Access Controller Reader:** Place the card on the reader of the Access Controller and click **Read** to get the card No.
 - **Card Enrollment Station:** Place the card on the Card Enrollment Station and click **Read** to get the card No.

Note: The Card Enrollment Station should connect with the PC running the client. You can click **Set Card Enrollment Station** to enter the following dialog.

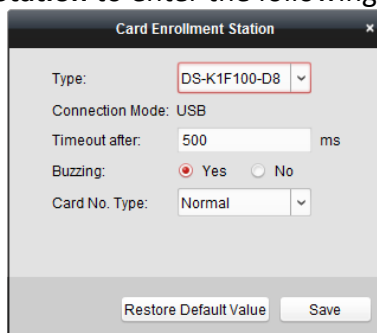

- Select the Card Enrollment Station type.

Note: Currently, the supported card reader types include DS-K1F100-D8, DS-K1F100-M, DS-K1F100-D8E, and DS-K1F180-D8E.

- Set the parameters about the connected card enrollment station.
- Click **Save** button to save the settings.

You can click **Restore Default Value** button to restore the defaults.

- **Manually Input:** Input the card No. and click **Enter** to input the card No.

- After issuing the card to the person, the person and card information will display in the Person(s) with Card Issued list.
- Click **OK** to save the settings.

7.6 Schedule and Template

Purpose:

You can configure the template including week schedule and holiday schedule. After setting the templates, you can adopt the configured templates to access control permissions when setting the permission, so that the access control permission will take effect in the time durations of the template.

Click  to enter the schedule and template interface.

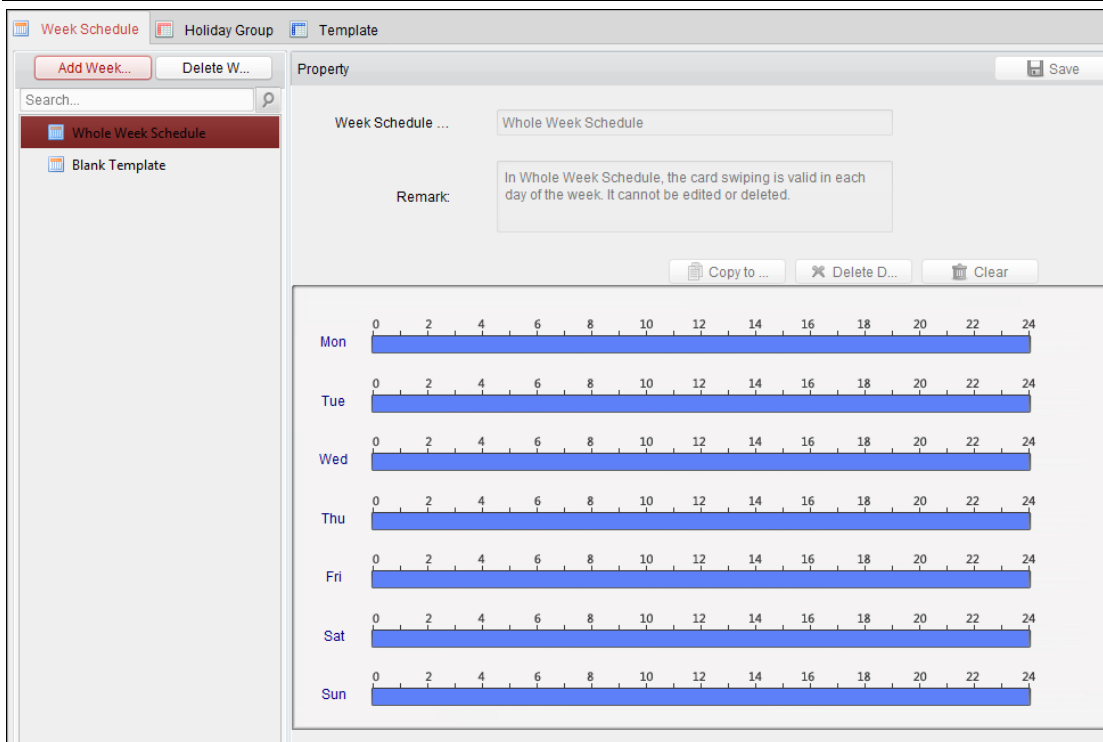

You can manage the schedule of access control permission including Week Schedule, Holiday Schedule, and Template. For permission settings, please refer to *Chapter 7.7 Permission Configuration*.

7.6.1 Week Schedule

Click **Week Schedule** tab to enter the Week Schedule Management interface.

The client defines two kinds of week plan by default: **Whole Week Schedule** and **Blank Schedule**, which cannot be deleted and edited.

- **Whole Week Schedule:** Card swiping is valid on each day of the week.
- **Blank Schedule:** Card swiping is invalid on each day of the week.

You can perform the following steps to define custom schedules on your demand.

Steps:

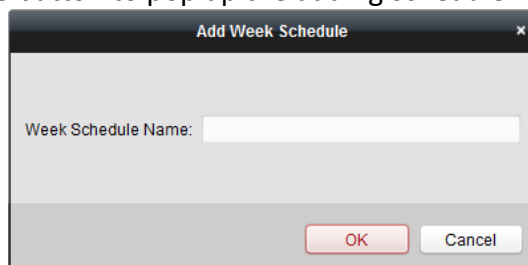

1. Click **Add Week Schedule** button to pop up the adding schedule interface.



2. Input the name of week schedule and click **OK** button to add the week schedule.
3. Select the added week schedule in the schedule list and you can view its property on the right. You can edit the week schedule name and input the remark information.
4. On the week schedule, click and drag on a day to draw on the schedule, which means in that

period of time, the configured permission is activated.

Note: Up to 8 time periods can be set for each day in the schedule.

5. When the cursor turns to , you can move the selected time bar you just edited. You can also edit the displayed time point to set the accurate time period. When the cursor turns to , you can lengthen or shorten the selected time bar.
6. Optionally, you can select the schedule time bar, and then click **Delete Duration** to delete the selected time bar, or click **Clear** to delete all the time bars, or click **Copy to Week** to copy the time bar settings to the whole week.
7. Click **Save** to save the settings.

7.6.2 Holiday Group

Click **Holiday Group** tab to enter the Holiday Group Management interface.

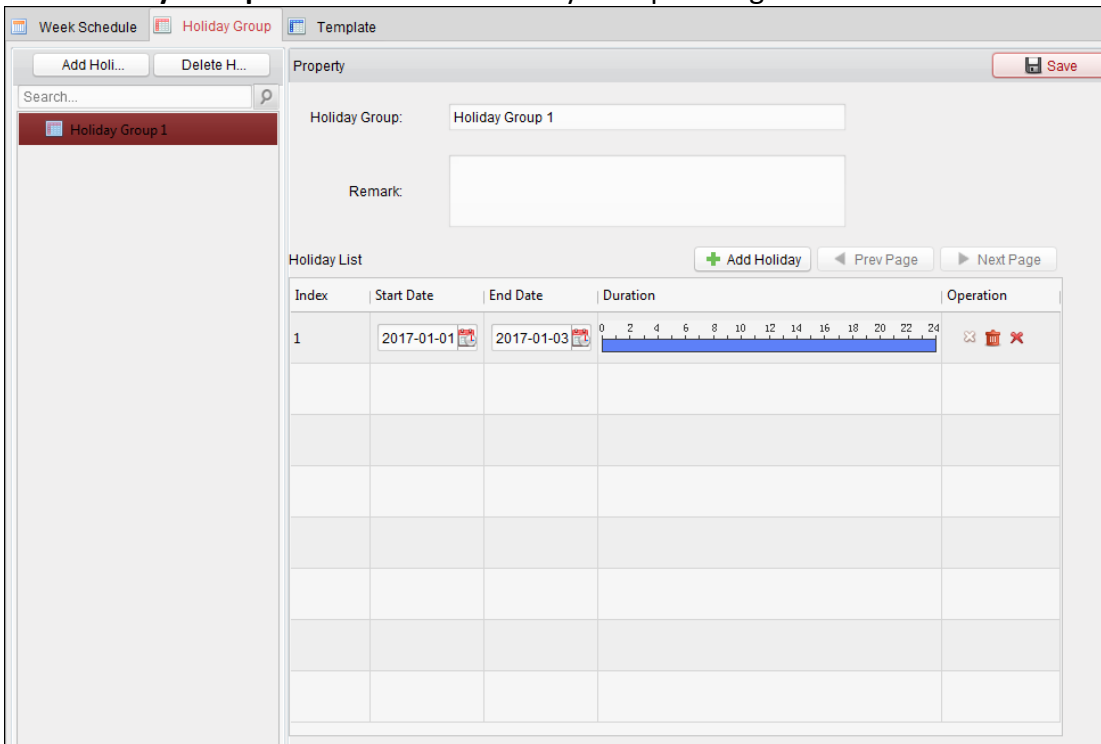

Steps:

1. Click **Add Holiday Group** button on the left to pop up the adding holiday group interface.

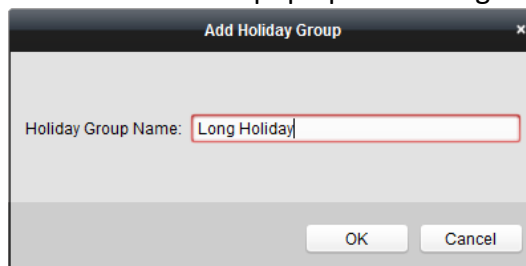

2. Input the name of holiday group in the text filed and click **OK** button to add the holiday group.
3. Select the added holiday group and you can edit the holiday group name and input the remark

information.



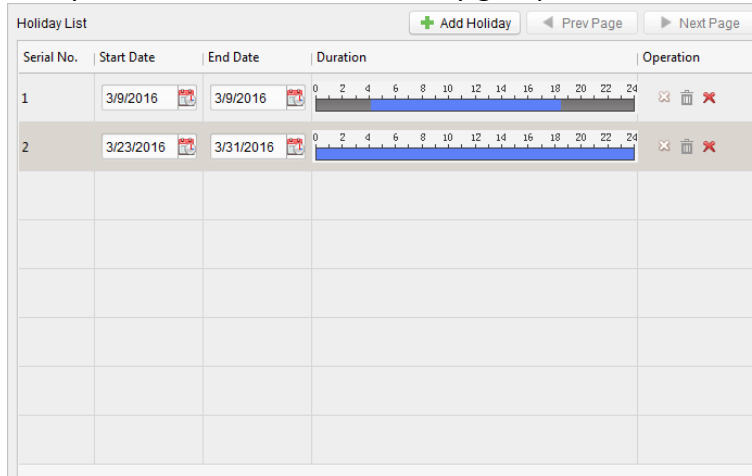

- Click **Add Holiday** icon on the right to add a holiday period to the holiday list and configure the duration of the holiday.

Note: Up to 16 holidays can be added to one holiday group.



- On the period schedule, click and drag to draw the period, which means in that period of time, the configured permission is activated.

Note: Up to 8 time durations can be set for each period in the schedule.

- When the cursor turns to , you can move the selected time bar you just edited. You can also edit the displayed time point to set the accurate time period.
- When the cursor turns to , you can lengthen or shorten the selected time bar.
- Optionally, you can select the schedule time bar, and then click  to delete the selected time bar, or click  to delete all the time bars of the holiday, or click  to delete the holiday directly.

- Click **Save** to save the settings.

Note: The holidays cannot be overlapped with each other.

7.6.3 Template

After setting the week schedule and holiday group, you can configure the template which contains week schedule and holiday group schedule.

Note: The priority of holiday group schedule is higher than the week schedule.

Click **Template** tab to enter the Template Management interface.

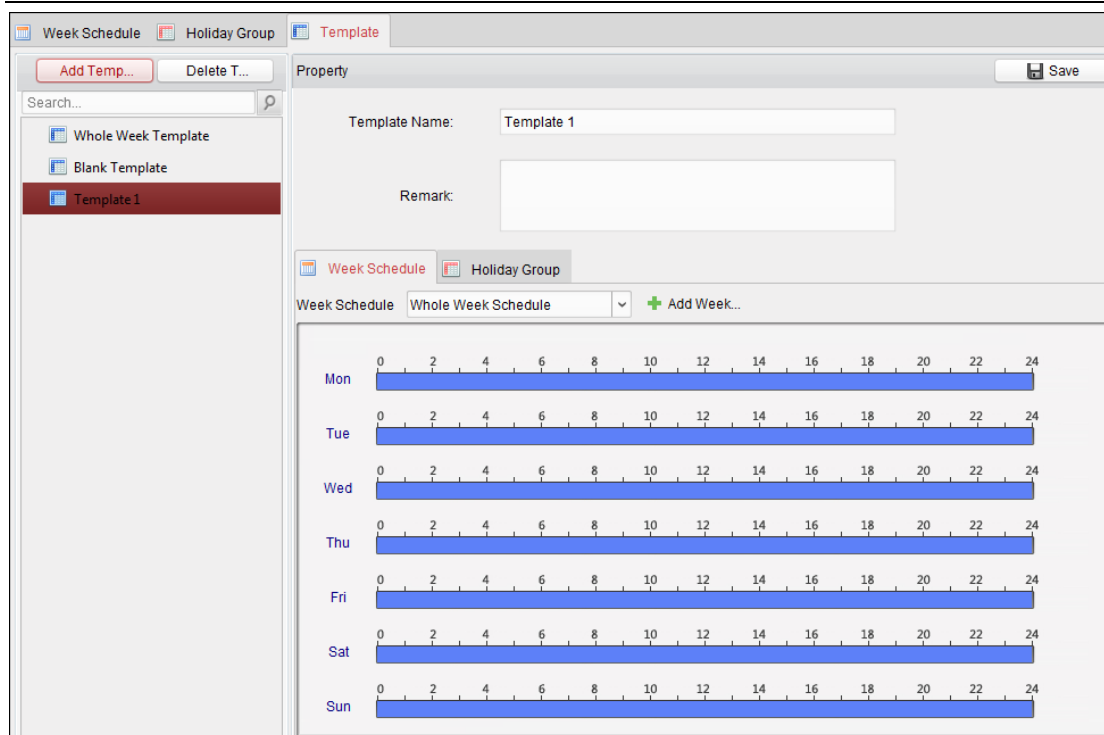

There are two pre-defined templates by default: **Whole Week Template** and **Blank Template**, which cannot be deleted and edited.

- **Whole Week Template:** The card swiping is valid on each day of the week and it has no holiday group schedule.
- **Blank Template:** The card swiping is invalid on each day of the week and it has no holiday group schedule.

You can define custom templates on your demand.

Steps:

1. Click **Add Template** to pop up the adding template interface.

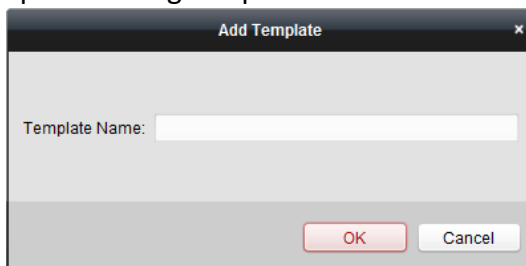

2. Input the template name in the text field and click **OK** button to add the template.
3. Select the added template and you can edit its property on the right. You can edit the template name and input the remark information.
4. Select a week schedule to apply to the schedule.
Click **Week Schedule** tab and select a schedule in the dropdown list.
You can also click **Add Week Schedule** to add a new week schedule. For details, refer to *Chapter 7.6.1 Week Schedule*.

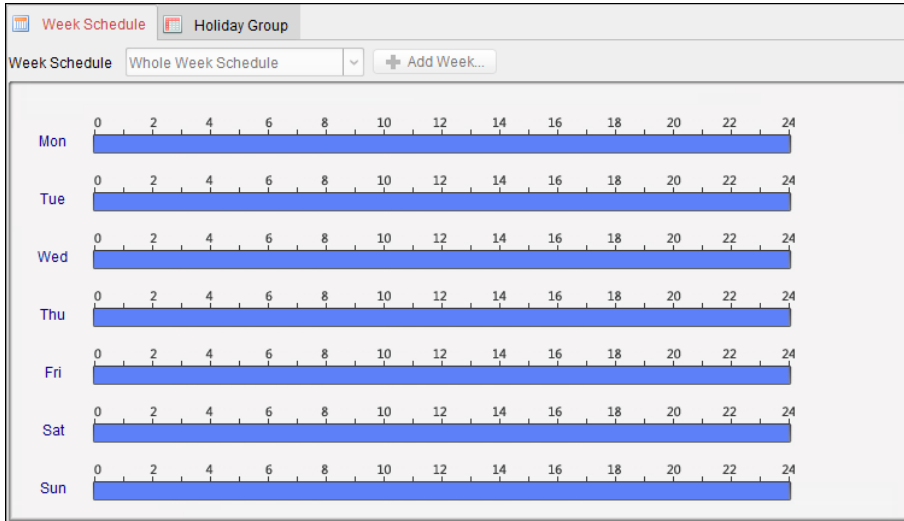

5. Select holiday groups to apply to the schedule.

Note: Up to 4 holiday groups can be added.

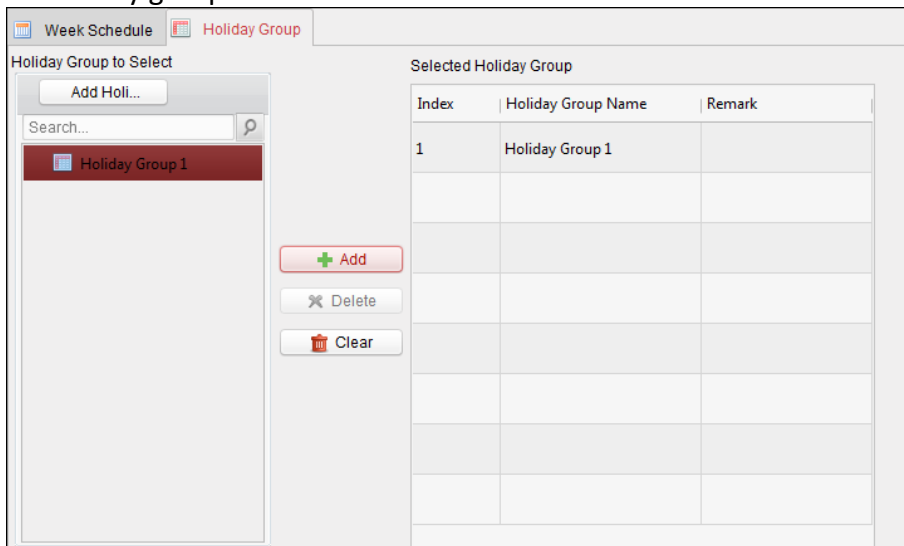

Click to select a holiday group in the list and click **Add** to add it to the template. You can also click **Add Holiday Group** to add a new one. For details, refer to *Chapter 7.6.2 Holiday Group*. You can click to select an added holiday group in the right-side list and click **Delete** to delete it. You can click **Clear** to delete all the added holiday groups.

6. Click **Save** button to save the settings.

7.7 Permission Configuration

In Permission Configuration module, you can add, edit, and delete the access control permission, and then apply the permission settings to the device to take effect.

Click  icon to enter the Access Control Permission interface.

Permission Name	Template	Person	Door	Details	Status
Door 2 Permissi...	Whole Week Te...	Wendy	Door Station	Details	Not Applied
Door 1 Permissi...	Whole Week Te...	Wendy,Yining	Door1_10.16.6.1...	Details	Applying failed

7.7.1 Adding Permission

Purpose:

You can assign permission for persons to enter/exist the access control points (doors) in this section.

Steps:

1. Click **Add** icon to enter following interface.

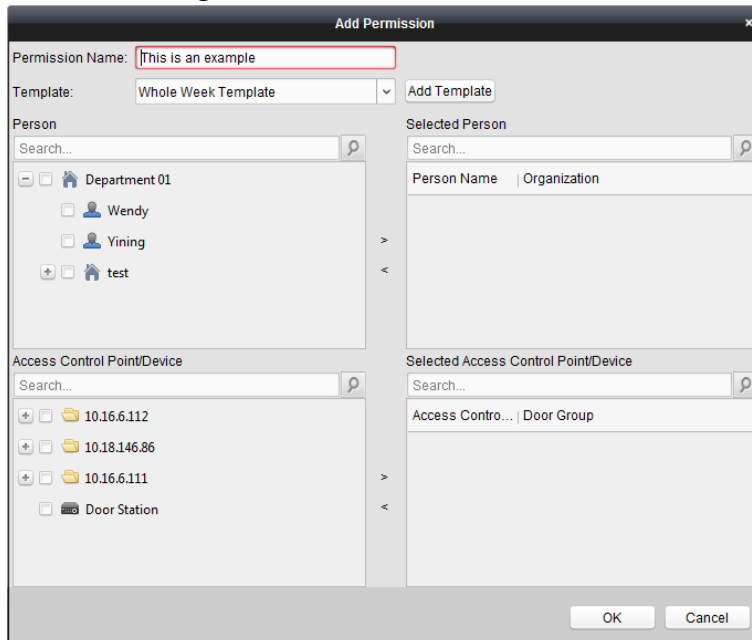

2. In the Permission Name field, input the name for the permission as desired.
3. Click on the dropdown menu to select a template for the permission.

Note: You should configure the template before permission settings. You can click **Add Template** button to add the template. Refer to *Chapter 7.6 Schedule and Template* for details.
4. In the Person list, all the added persons display. Check the checkbox(es) to select person(s) and click > to add to the Selected Person list. (Optional) You can select the person in Selected Person list and click < to cancel the selection.
5. In the Access Control Point/Device list, all the added access control points (doors) and door stations will display. Check the checkbox(es) to select door(s) or door station(s) and click > to add to the selected list. (Optional) You can select the door or door station in the selected list and click < to cancel the selection.
6. Click **OK** button to complete the permission adding. The selected person will have the

permission to enter/exit the selected door/door station with their linked card(s) or fingerprints.

7. (Optional) after adding the permission, you can click **Details** to modify it. Or you can select the permission and click **Modify** to modify.

You can select the added permission in the list and click **Delete** to delete it.

7.7.2 Applying Permission

Purpose:

After configuring the permissions, you should apply the added permission to the access control device to take effect.

Steps:

1. Select the permission(s) to apply to the access control device. To select multiple permissions, you can hold the *Ctrl* or *Shift* key and select permissions.
2. Click **Apply to Device** to start applying the selected permission(s) to the access control device or door station.
3. The following window will pop up, indicating the applying permission result.

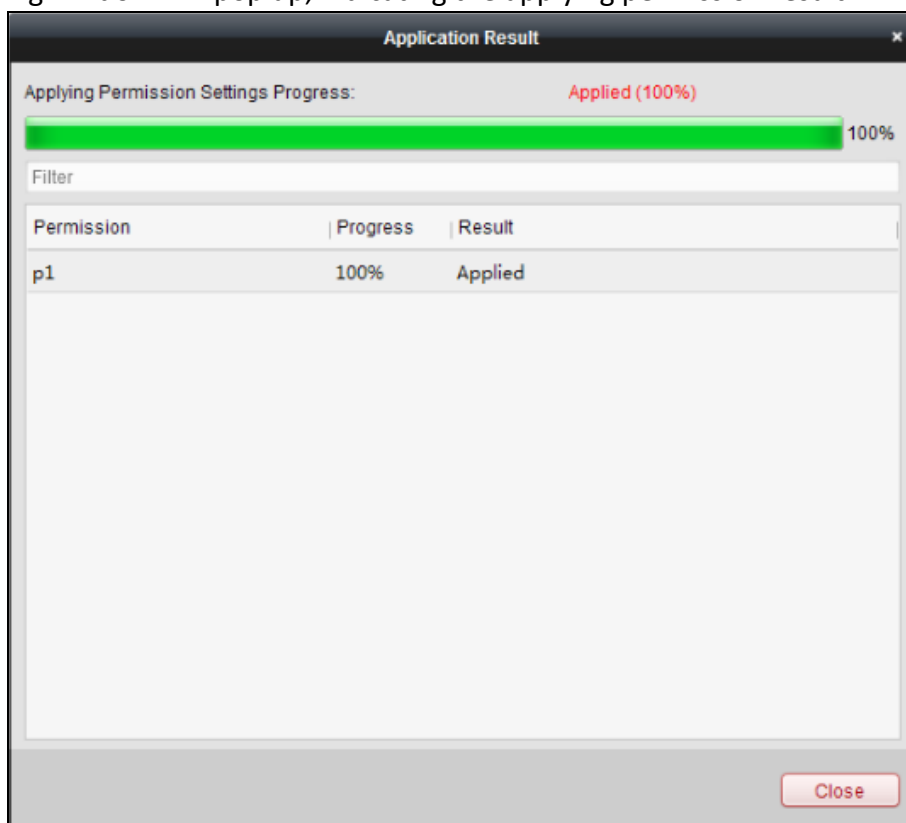

7.8 Advanced Functions

Purpose:

After configuring the person, template, and access control permission, you can configure the advanced functions of access control application.

Note: The advanced functions should be supported by the device.

Click  icon to enter the following interface.

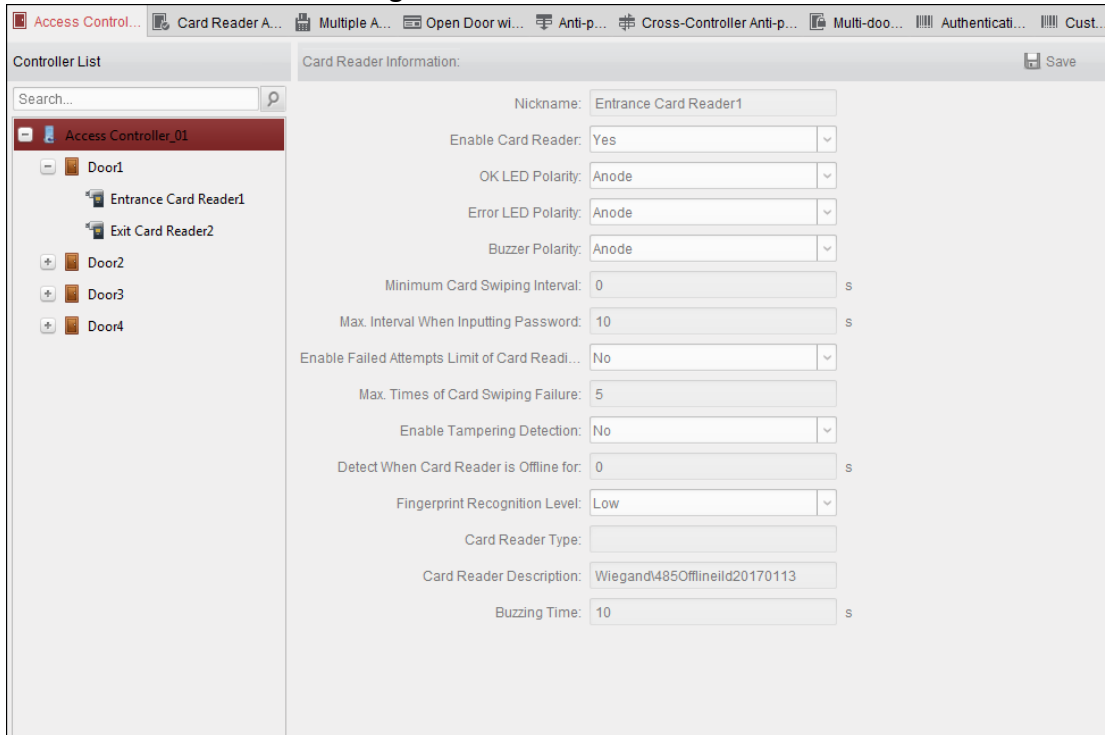

7.8.1 Access Control Parameters

Purpose:

After configuring the person, template, and access control permission, you can configure the advanced functions of access control application.

Click **Access Control Parameters** tab to enter the parameters settings interface.

Door Parameters

Steps:

1. In the controller list on the left, click  to expand the access control device, select the door (access control point) and you can edit the information of the selected door on the right.
2. You can editing the following parameters:

Door Magnetic: The Door Magnetic is in the status of **Remain Closed** (excluding special conditions).

Exit Button Type: The Exit Button Type is in the status of **Remain Open** (excluding special conditions).

Door Locked Time: After swiping the normal card and relay action, the timer for locking the door starts working.

Door Open Duration by Card for Door Extended Opening: The door magnetic can be enabled with appropriate delay after card holder swipes the card.

Door Open Timeout Alarm: The alarm can be triggered if the door has not been close

Enable Locking Door when Door Closed (Reserved): The door can be locked once it is closed

even if the Door Locked Time is not reached.

Duress Code: The door can open by inputting the duress code when there is duress. At the same time, the client can report the duress event.

Super Password: The specific person can open the door by inputting the super password.

Dismiss Code: Input the dismiss code to stop the buzzer of the card reader.

Notes:

- The duress code, Super password, and dismiss code should be different.
 - The duress code, super password, and the dismiss code should be different from the authentication password.
 - The duress code, super password, and the dismiss code should contain 4 to 8 numerics.
3. Click **Save** button to save parameters.

Card Reader Parameters

Steps:

1. In the device list on the left, click  to expand the door, select the card reader name and you can edit the card reader parameters on the right.
2. You can editing the following parameters:
 - Nickname:** Edit the card reader name as desired.
 - Enable Card Reader:** Select **Yes** to enable the card reader.
 - OK LED Polarity:** Select the OK LED Polarity of the card reader mainboard.
 - Error LED Polarity:** Select the Error LED Polarity of the card reader mainboard.
 - Buzzer Polarity:** Select the Buzzer LED Polarity of the card reader mainboard.
 - Minimum Card Swiping Interval:** If the interval between card swiping of the same card is less than the set value, the card swiping is invalid. You can set it as 0 to 255.
 - Max. Interval When Inputting Password:** When you inputting the password on the card reader, if the interval between pressing two digits is larger than the set value, the digits you pressed before will be cleared automatically.
 - Enable Failed Attempts Limit of Card Reading:** Enable to report alarm when the card reading attempts reach the set value.
 - Max. Times of Card Swiping Failure:** Set the max. failure attempts of reading card.
 - Enable Tampering Detection:** Enable the anti-tamper detection for the card reader.
Note: For DS-K2800 series access controller, the function is not supported yet.
 - Detect When Card Reader is Offline for:** When the access control device cannot connect with the card reader for longer than the set time, the card reader will turn offline automatically.
Note: For DS-K2800 series access controller, the function is not supported yet.
 - Buzzing Time:** Set the card reader buzzing time. The available time ranges from 0 to 5999s. 0 represents continuous buzzing.
 - Card Reader Description:** Read the card reader description.
3. Click the **Save** button to save parameters.

7.8.2 Card Reader Authentication

Purpose:

You can set the passing rules for the card reader of the access control device.

Steps:

1. Click **Card Reader Authentication** tab and select a card reader on the left.
2. Select a card reader authentication mode. The available authentication modes depend on the card reader type:
 - **Card and Password:** The door can open by both inputting the card password and swiping the card.
Note: Here the password refers to the password set when issuing the card to the person. *Chapter 7.5.2 Person Management.*
 - **Card or Authentication Password:** The door can open by inputting the authentication password or swiping the card.
Note: Here the authentication password refers to the password set to open the door. Refer to *Chapter 7.8.5 Authentication Password.*
 - **Card:** The door can open by only swiping the card.
3. Click and drag your mouse on a day to draw a color bar on the schedule, which means in that period of time, the card reader authentication is valid.
4. Repeat the above step to set other time periods.
 Or you can select a configured day and click **Copy to Week** button to copy the same settings to the whole week.
 (Optional) You can click **Delete** button to delete the selected time period or click **Clear** button to delete all the configured time periods.
5. (Optional) Click **Copy to** button to copy the settings to other card readers.

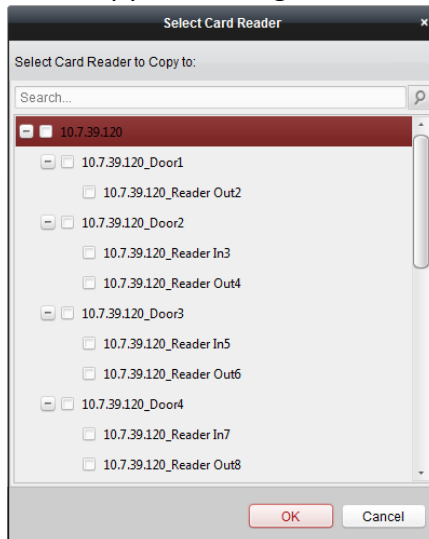

6. Click **Save** button to save parameters.

7.8.3 Open Door with First Card

Purpose:

You can set multiple first cards for one access control point. After the first card swiping, it allows multiple persons access the door or other authentication actions. The first card mode contains Remain Open with First Card, Disable Remain Open with First Card, and First Card Authorization.

Remain Open with First Card: The door remains open for the configured time duration after the first card swiping until the remain open duration ends.

First Card Authorization: All authentications, except for the authentications of super card, duress card, and duress code, are allowed only after the first card authorization.

Steps:

1. Click **Open Door with First Card** tab to enter the following interface.

Access Control Point	First Card Mode	Remain Open Duration (mins)
Door1	Remain Open with First Card	10
Door2	Disable Remain Open with ...	10

Card No.	Person Name	Effective Date	Expiry Date
----------	-------------	----------------	-------------

2. Select an access control device from the list on the left.
3. Select the first card mode in the drop-down list for the access control point.
4. (Optional) If you select Remain Open with First Card, you should set remain open duration.

Notes:

- The Remain Open Duration should be between 0 and 1440 minutes. By default, it is 10 minutes.
 - In the First Card Authorization mode, you can access the door when swiping the super card, the duress card or input the duress code without swiping the first card.
 - You can swipe the first card again to disable the first card mode.
 - The first card authorization is effective only on the current day. The authorization will be expired after 24:00 on the current day.
5. In the First Card list, Click **Add** button to pop up the following dialog box.

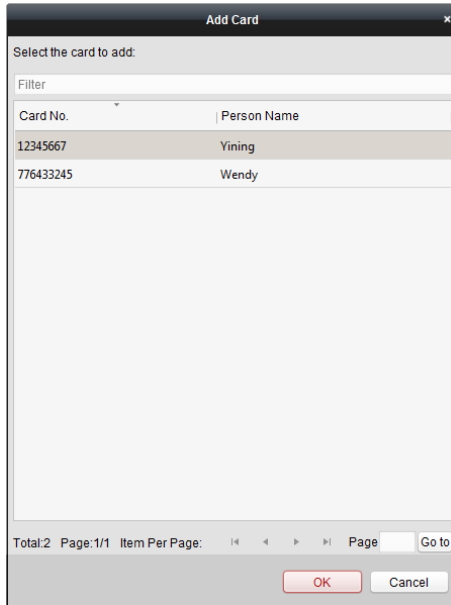

- 1) Select the cards to add as first card for the door
Note: Please set the card permission and apply the permission setting to the access control device first. For details, refer to *Chapter 7.7 Permission Configuration*.
- 2) Click **OK** button to save adding the card.
6. You can click **Delete** button to remove the card from the first card list.
7. Click **Save** to save and take effect of the new settings.

7.8.4 Anti-Passing Back

Purpose:

You can set anti-passing back for card readers in the same access controller. You should swipe the card according to the configured swiping card route. And only one person could pass the access control point after swiping the card.

Notes:

- Either the anti-passing back or multi-door interlocking function can be configured for an access control device at the same time.
- You should enable the anti-passing back function on the access control device first.

Setting the Path of Swiping Card (Card Reader Order)

Steps:

1. Click **Anti-passing Back** tab to enter the following interface.

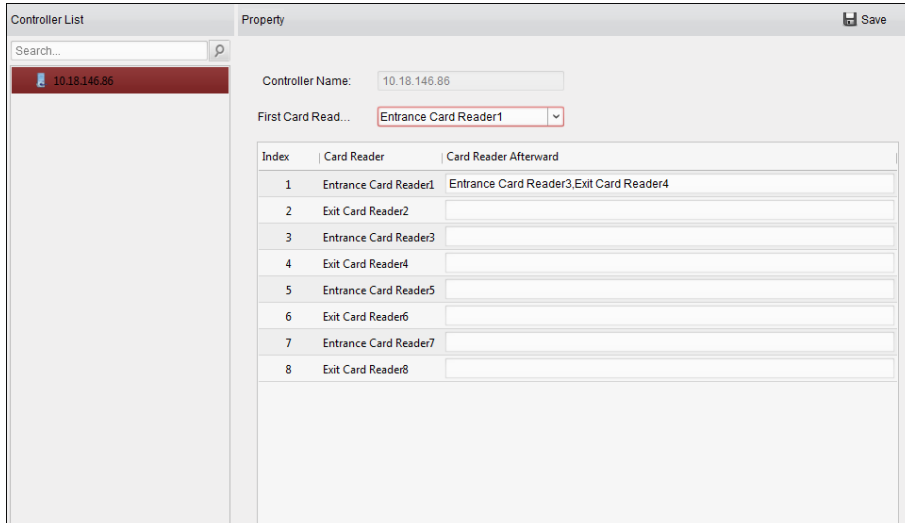

2. Select an access control device from the device list on the left.
3. In the First Card Reader field, select the card reader as the beginning of the path.
4. In the list, click the text filed of **Card Reader Afterward** and select the linked card readers.
Example: If you select Reader In_01 as the beginning, and select Reader In_02, Reader Out_04 as the linked card readers. Then you can only get through the access control point by swiping the card in the order as Reader In_01, Reader In_02 and Reader Out_04.

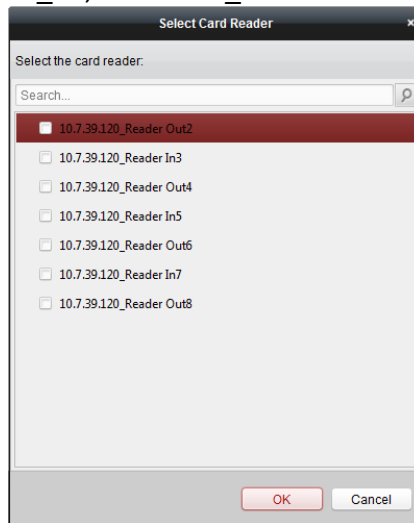

- Note:** Up to four afterward card readers can be added for one card reader.
5. (Optional) You can enter the Select Card Reader dialog box again to edit its afterward card readers.
 6. Click **Save** to save and take effect of the new settings.

7.8.5 Authentication Password

Purpose:

You can open the door by inputting the authentication password on the card reader keypad after finishing the operation of setting authentication password.

Notes:

- This authentication password function is only valid during the schedules when the card reader authentication mode for the access control device is set as **Card or Authentication Password**. For details, please refer to *Chapter 7.8.2 Card Reader Authentication*.
- This function should be supported by the access control device.

Steps:

1. Click **Authentication Password** tab and select an access control device from the list.

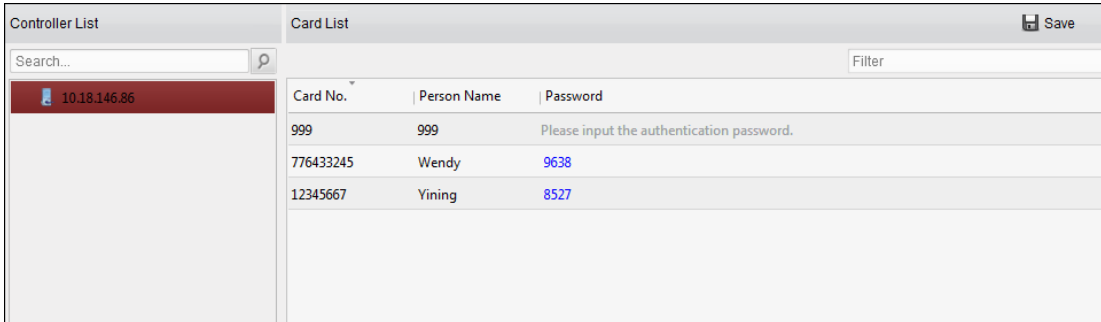

All the cards and persons which have been applied to the device will be displayed.

Note: For setting and applying the permissions to the device, refer to *Chapter 7.7 Permission Configuration*.

2. Click the **Password** field of the card and input the authentication password for the card.
Note: The authentication password should contain 4 to 8 digits.
3. After setting the authentication password, the authentication password function of the card will be enabled by default.
4. (Optional) You can input the keywords of card No., person name, or authentication password to search.

Notes:

- Up to 500 cards with authentication password can be added to one access control device.
- The password should be unique and cannot be the same with super password, duress code, and dismiss code in the access control parameters.

7.8.6 Custom Wiegand

Purpose:

Based on the knowledge of uploading rule for the third party wiegand, you can set multiple customized wiegand protocols to communicate between the controller and the third party card readers.

Before you start:

Wire the third party card readers to the controller.

Steps:

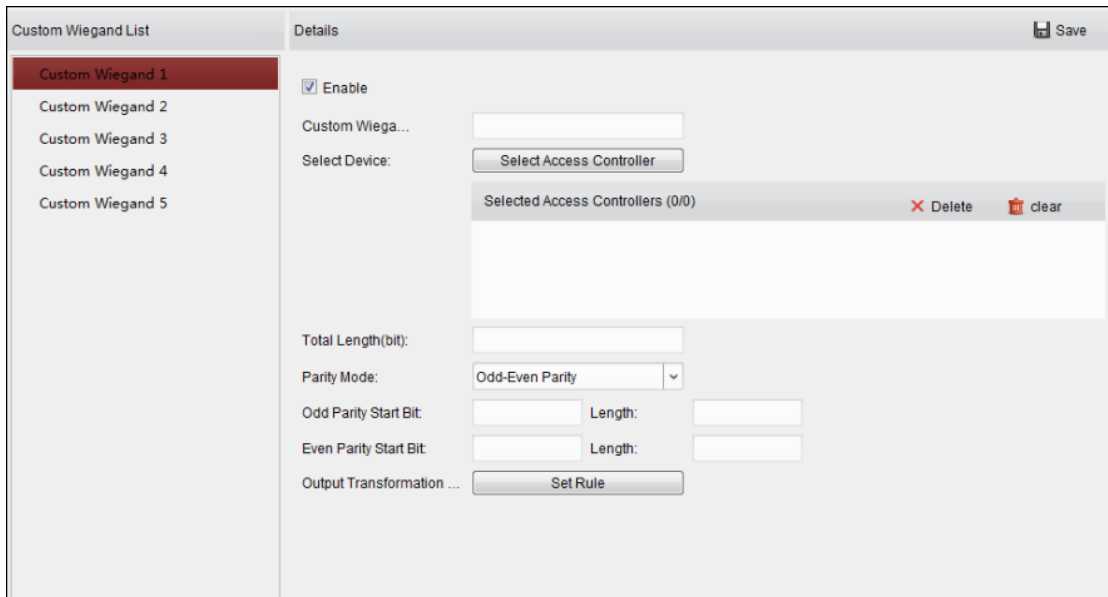

1. Click **Custom Wiegand** to enter the Custom Wiegand tab.

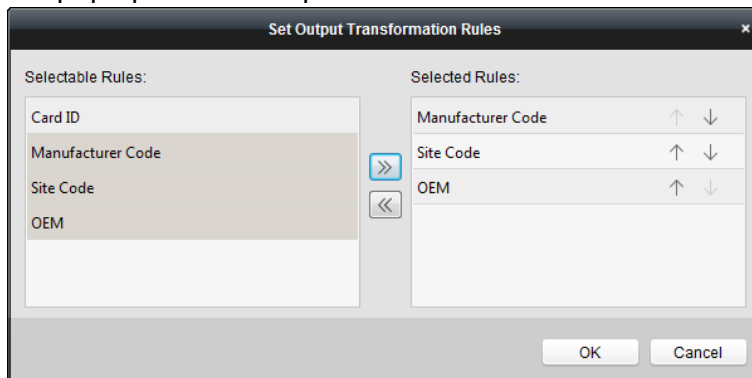

2. Select a custom wiegand on the left of the interface.
3. Check **Enable** checkbox to enable the custom wiegand.
4. Set the wiegand name.
5. Select device.
 - 1) Click **Select Device**.
 - 2) Select the device need to use custom wiegand.
 - 3) Click **OK** to save the settings.
6. Input the Total Length and select the parity mode in the drop-down list.
 If you select Odd-Even Parity, you should set the odd parity start bit, the odd parity length, the even parity start bit and the even parity length.
 If you select XOR Parity, you should set the XOR parity start bit, length per group and total length.
 If you select None, you are no need to set the parity mode.
7. Set output transformation rule.
 - 1) Click **Set Rule** to pop up the Set Output Transformation Rules window.



- 2) Select rules on the left list.
Note: Press the *Shift* key to select multiple rules.
- 3) Click  to move the selected rules to the right list.

- 4) (Optional) Click  or  to change the rule order.
 - 5) (Optional) Select the rules in the Selected Rule list and click  to remove the rule from the list on the right.
 - 6) Click **OK** to save the settings.
 - 7) In the Custom Wiegand tab, set the rule start bit, length, and the decimal digit.
8. Click **Save** at the upper right corner of the interface to save the settings.

Notes:

- By default, the device disables the custom wiegand function.
- If the device enables the custom wiegand function, all wiegand interfaces in the device will use the customized wiegand protocol.
- Up to 5 custom wiegands can be set.
- Up to 32 characters are allowed in the custom wiegand name.
- Up to 80 bits are available in the total length.
- The odd parity start bit, the odd parity length, the even parity start bit and the even parity length range from 1 to 80 bit.
- The start bit of the card ID, the manufacturer code, the site code, and the OEM should range from 1 to 80 bit.
- For details about the custom wiegand, see Appendix.

7.9 Searching Access Control Event

Purpose:

You can search the access control history events including device exception event, door event, alarm input, and card reader event.

Click  icon and click Access Control Event tab to enter the following interface.

Steps:

1. Select the source.
You can select Client or Device.
2. Enter the search condition (source, event type/card holder name/card No./capture/start & end time).
3. Click **Search** to get the search results.
4. View the event information in the event list.
5. Click an event to view the information of the card holder on the **Card Holder Information** panel on the left side of the page.
6. You can click **Export** button to export the search results to the local PC.

7.10 Access Control Event Configuration

Purpose:

For the added access control device, you can configure its access control linkage including access control event linkage, access control alarm input linkage, event card linkage, and cross-device linkage.



Click the  icon on the control panel, or click **Tool->Event Management** to open the Event Management page.

7.10.1 Access Control Event Linkage

Purpose:

You can assign linkage actions to the access control event by setting up a rule. For example, when the access control event is detected, an audible warning appears or other linkage actions happen.

Note: The linkage here refers to the linkage of the client software’s own actions.

Steps:

1. Click the **Access Control Event** tab.
2. The added access control devices will display in the Access Control Device panel on the left. Select the access control device, or alarm input, or access control point (door), or card reader to configure the event linkage.
3. Select the event type to set the linkage.
4. Select the triggered camera. The image or video from the triggered camera will pop up when the selected event occurs.
To capture the picture of the triggered camera when the selected event occurs, you can also set the capture schedule and the storage in Storage Schedule.
5. Check the checkboxes to activate the linkage actions. For details, refer to *Table 14.1 Linkage Actions for Access Control Event*.
6. Click **Save** to save the settings.
7. You can click Copy to button to copy the access control event to other access control device, alarm input, access control point, or card reader.
Select the parameters for copy, select the target to copy to, and click **OK** to confirm.

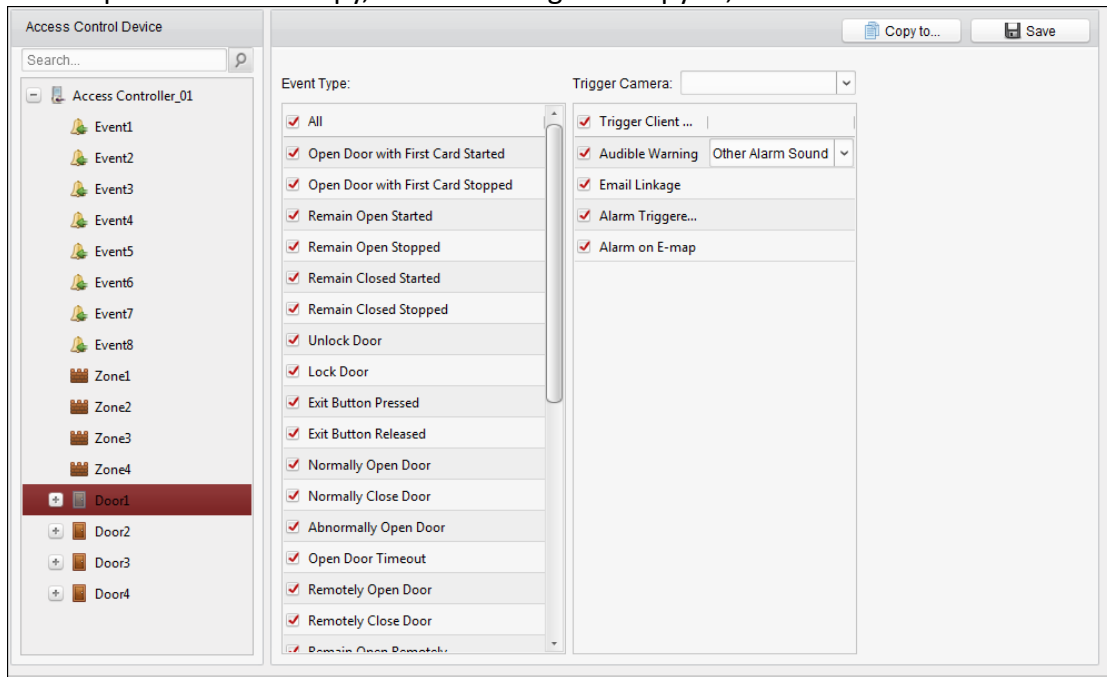

Table 1. 1 Linkage Actions for Access Control Event

Linkage Actions	Descriptions
Audible Warning	The client software gives an audible warning when alarm is triggered. You can select the alarm sound for audible warning.
Email Linkage	Send an email notification of the alarm information to one or more receivers.
Alarm on E-map	Display the alarm information on the E-map. Note: This linkage is only available to access control point and alarm input.

Alarm Triggered Pop-up Image	The image with alarm information pops up when alarm is triggered.
-------------------------------------	---

7.10.2 Access Control Alarm Input Linkage

Purpose:

The access control alarm inputs can be linked to some actions (e.g., alarm output, host buzzer) when it is triggered.

Note: The linkage here refers to the linkage of the client software’s own actions.

Steps:

1. Click **Access Control Alarm Input** tab to enter the following interface.

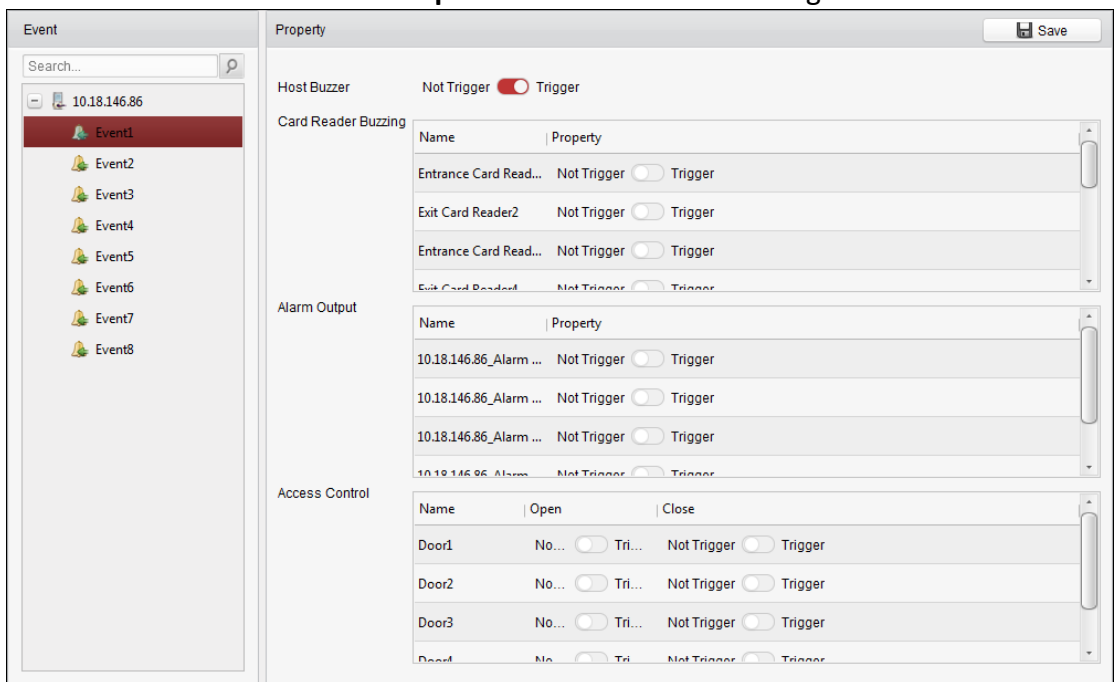

2. In the event list on the left, select an alarm input.
3. Switch the property from to to enable this action.
 - Host Buzzer:** The audible warning of controller will be triggered.
 - Card Reader Buzzer:** The audible warning of card reader will be triggered.
 - Alarm Output:** The alarm output will be triggered for notification.
 - Access Control Point (Open/Close):** The door will be open or closed when the case is triggered.

Note: The Door cannot be configured as open or closed at the same time.
4. Click **Save** button to save the settings.

7.10.3 Event Card Linkage

Click **Event Card Linkage** tab to enter the following interface.

Notes:

- The Event Card Linkage should be supported by the device.

- The linkage here refers to the linkage of the client software's own actions.



Select the access control device from the list on the left.

Click **Add** button to add a new linkage. You can select the event source as **Event Linkage** or **Card Linkage**.

Event Linkage

For the event linkage, the alarm event can be divided into four types: device event, alarm input, door event, and card reader event.

Steps:



1. Click to select the linkage type as **Event Linkage**, and select the event type from the dropdown list.
 - For Device Event, select the detailed event type from the dropdown list.
 - For Alarm Input, select the type as alarm or alarm recovery and select the alarm input name from the table.
 - For Door Event, select the detailed event type and select the source door from the table.
 - For Card Reader Event, select the detailed event type and select the card reader from the table.
2. Set the linkage target, and switch the property from  to  to enable this function.
 - **Host Buzzer:** The audible warning of controller will be enabled/disabled.
 - **Capture:** The real-time capture will be enabled.
 - **Card Reader Buzzer:** The audible warning of card reader will be enabled/disabled.
 - **Alarm Output:** The alarm output will be enabled/disabled for notification.
 - **Access Control Point:** The door status of open, close, remain open, and remain closed will be enabled.

Notes:

- The door status of open, close, remain open, and remain close cannot be triggered at the same time.
 - The target door and the source door cannot be the same one.
3. Click **Save** button to save and take effect of the parameters.

Card Linkage

Steps:

1. Click to select the linkage type as **Card Linkage**.
2. Input the card No. or select the card from the dropdown list.
3. Select the card reader from the table for triggering.
4. Set the linkage target, and switch the property from  to  to enable this function.
 - **Host Buzzer:** The audible warning of controller will be enabled/disabled.
 - **Capture:** The real-time capture will be enabled.
 - **Card Reader Buzzer:** The audible warning of card reader will be enabled/disabled.
 - **Alarm Output:** The alarm output will be enabled/disabled for notification.
 - **Access Control Point:** The door status of open, close, remain open, and remain closed will be enabled.

5. Click **Save** button to save and take effect of the parameters.

7.10.4 Cross-Device Linkage

Purpose:

You can assign to trigger other access control device's action by setting up a rule when the access control event is triggered.



Click **Cross-Device Linkage** tab to enter the following interface.

Click **Add** button to add a new client linkage. You can select the event source as **Event Linkage** or **Card Linkage**.

Event Linkage

For the event linkage, the alarm event can be divided into four types: device event, alarm input, door event, and card reader event.

Steps:

- Click to select the linkage type as **Event Linkage**, select the access control device as event source, and select the event type from the dropdown list.
 - For Device Event, select the detailed event type from the dropdown list.
 - For Alarm Input, select the type as alarm or alarm recovery and select the alarm input name from the table.
 - For Door Event, select the detailed event type and select the door from the table.
 - For Card Reader Event, select the detailed event type and select the card reader from the table.
- Set the linkage target, select the access control device from the dropdown list as the linkage target, and switch the property from  to  to enable this function.

- **Alarm Output:** The alarm output will be triggered for notification.
 - **Access Control Point:** The door status of open, close, remain open, and remain close will be triggered. **Note:** The door status of open, close, remain open, and remain close cannot be triggered at the same time.
3. Click **Save** button to save parameters.

Card Linkage

Steps:

1. Click to select the linkage type as **Card Linkage**.
2. Select the card from the dropdown list and select the access control device as event source.
3. Select the card reader from the table for triggering.
4. Set the linkage target, select the access control device from the dropdown list as the linkage target, and switch the property from to to enable this function.
Alarm Output: The alarm output will be triggered for notification.
5. Click **Save** button to save parameters.

7.11 Door Status Management

Purpose:

The door status of the added access control device will be displayed in real time. You can check the door status and the linked event(s) of the selected door. You can control the status of the door and set the status duration of the doors as well.

7.11.1 Access Control Group Management

Purpose:

Before controlling the door status and setting the status duration, you are required to organize it into group for convenient management.

Perform the following steps to create the group for the access control device:

Steps:

1. Click  on the control panel to open the Device Management page.
2. Click **Group** tab to enter the Group Management interface.

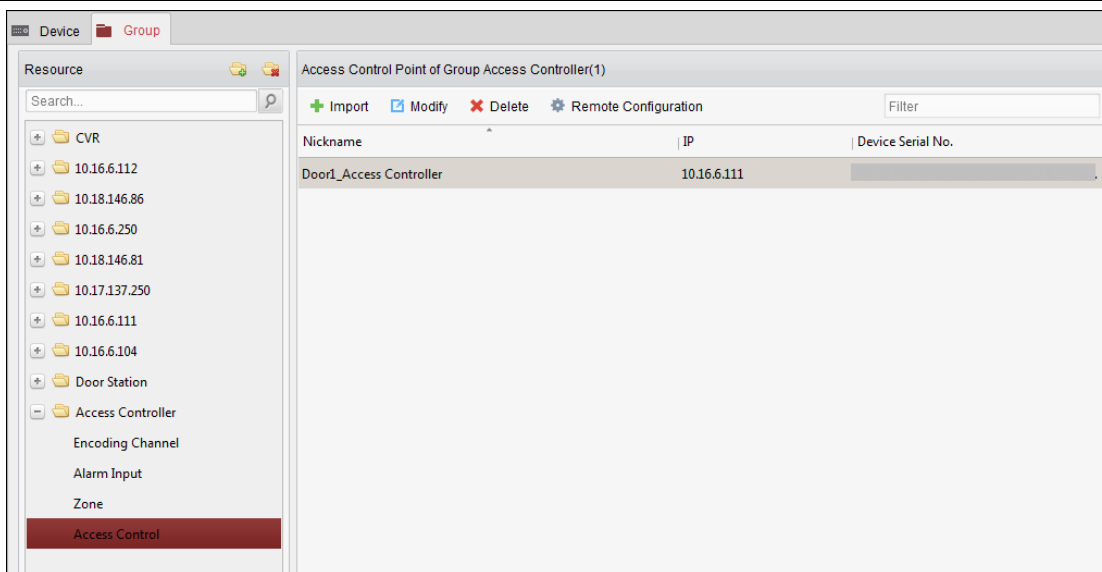

3. Perform the following steps to add the group.

- 1) Click  to open the Add Group dialog box.
- 2) Input a group name as you want.
- 3) Click **OK** to add the new group to the group list.

You can also check the checkbox **Create Group by Device Name** to create the new group by the name of the selected device.





4. Perform the following steps to import the access control points to the group:

- 1) Click **Import** on Group Management interface, and then click the **Access Control** tab to open the Import Access Control page.

Notes:

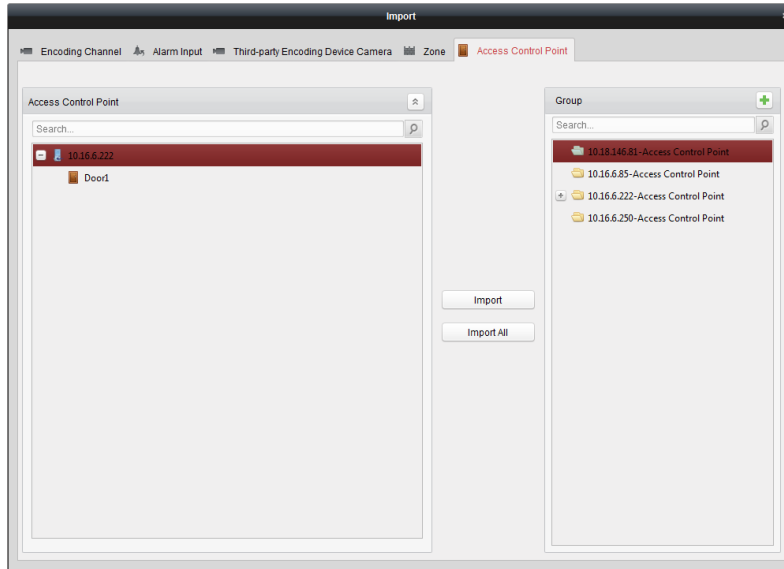
- You can also select **Alarm Input** tab and import the alarm inputs to group.
 - For the Video Access Control Terminal, you can add the cameras as encoding channel to the group.
- 2) Select the names of the access control points in the list.
 - 3) Select a group from the group list.
 - 4) Click **Import** to import the selected access control points to the group.
- You can also click **Import All** to import all the access control points to a selected group.



- After importing the access control points to the group, you can click , or double-click the group/access control point name to modify it.

7.11.2 Anti-control the Access Control Point (Door)

Purpose:

You can control the status for a single access control point (a door), including opening door, closing door, remaining open, and remaining closed.



Click  icon on the control panel to enter the Status Monitor interface.

Serial No.	Event Time	Door Group	Door	Operation	Operation Result	Capture
3	2017-01-18 20:2...	10.16.6.222	Door1_10.16.6.222	Open Door	Operation com...	
2	2017-01-18 20:2...	10.16.6.222	Door1_10.16.6.222	Door Remain O...	Operation com...	
1	2017-01-18 20:2...	10.16.6.222	Door1_10.16.6.222	Open Door	Operation com...	

Steps:

1. Select an access control group on the left. For managing the access control group, refer to *Chapter 7.11.1 Access Control Group Management*.
2. The access control points of the selected access control group will be displayed on the right.

Click icon  on the Status Information panel to select a door.

3. Click the following button listed on the **Status Information** panel to control the door.

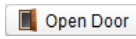
 **Open Door** : Click to open the door once.

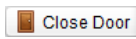
 **Close Door** : Click to close the door once.

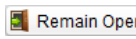
 **Remain Open** : Click to keep the door open.

 **Remain Closed** : Click to keep the door closed.

 **Capture** : Click to capture the picture manually.

4. You can view the anti-control operation result in the Operation Log panel.

Notes:

- If you select the status as **Remain Open/Remain Closed**, the door will keep open/closed until a new anti-control command being made.
- The **Capture** button is available when the device supports capture function. And it cannot be realized until the storage server is configured.
- If the door is in remain closed status, only super card can open the door or open door via the client software.

7.11.3 Status Duration Configuration

Purpose:

You can schedule weekly time periods for an access control point (door) to remain open or remain closed.

In the Door Status module, click **Status Duration** button to enter the Status Duration interface.

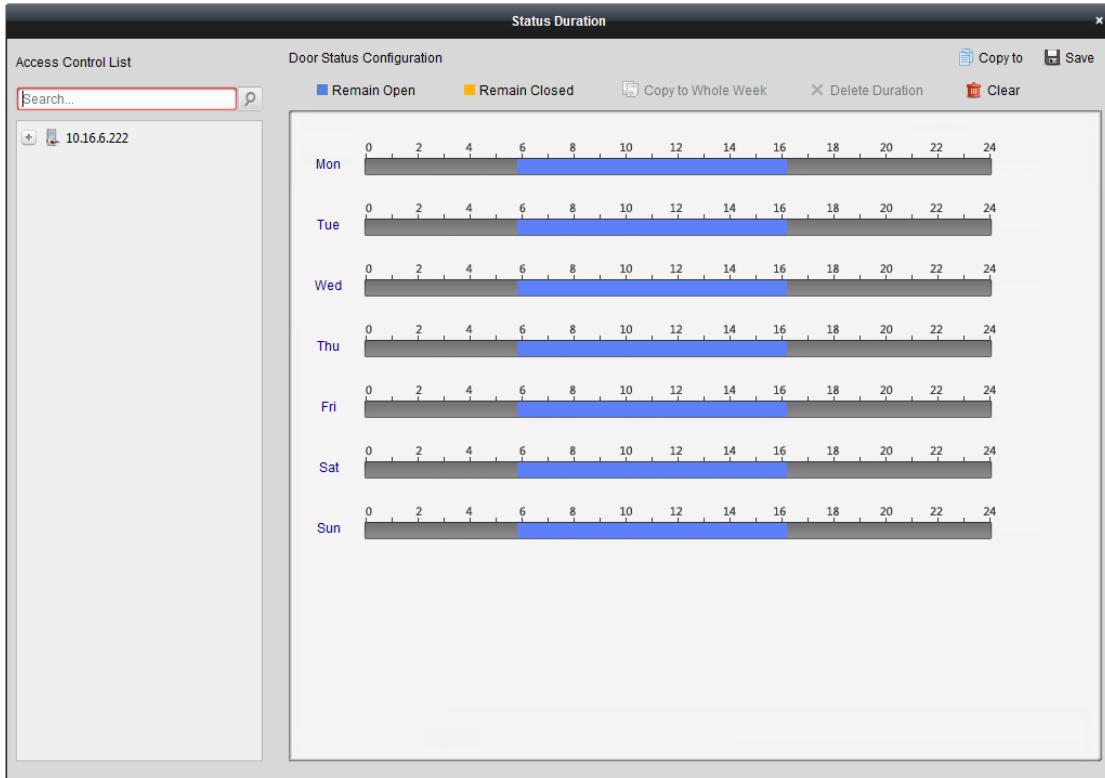

Steps:

1. Click to select a door from the access control device list on the left.
2. On the Door Status Configuration panel on the right, draw a schedule for the selected door.

- 1) Select a door status brush as Remain Open or Remain Closed.

Remain Open: The door will keep open during the configured time period. The brush is marked as ■.

Remain Closed: The door will keep closed during the configured duration. The brush is marked as ■.

- 2) Click and drag on the timeline to draw a color bar on the schedule to set the duration.

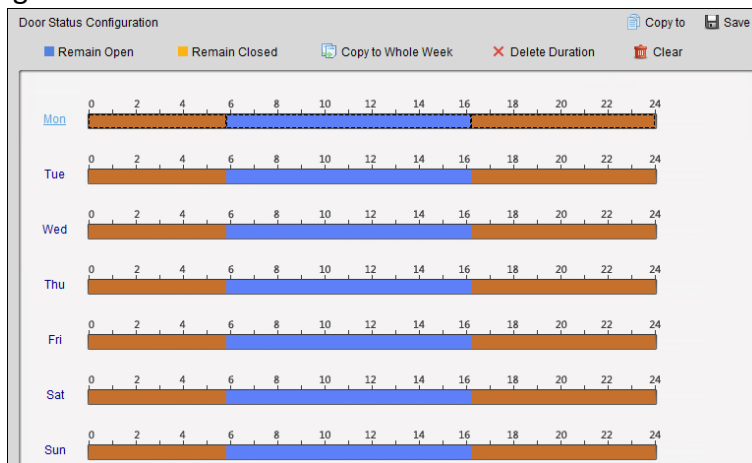

- 3) When the cursor turns to , you can move the selected time bar you just edited. You can also edit the displayed time point to set the accurate time period.

When the cursor turns to , you can lengthen or shorten the selected time bar.

3. Optionally, you can select the schedule time bar and click **Copy to Whole Week** to copy the

time bar settings to the other days in the week.

4. You can select the time bar and click **Delete Duration** to delete the time period.
Or you can click **Clear** to clear all configured durations on the schedule.
5. Click **Save** to save the settings.
6. You can click **Copy to** button to copy the schedule to other doors.

7.11.4 Real-time Card Swiping Record

Click **Card Swiping Record** tab to enter the following interface.

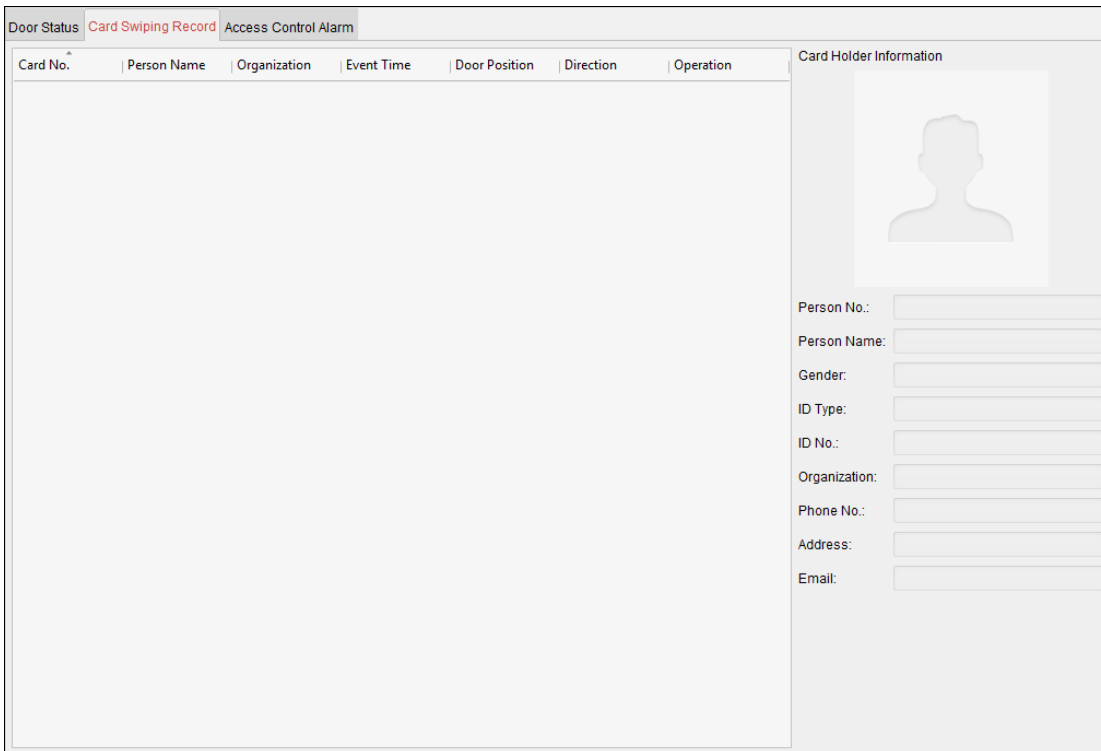

The logs of card swiping records of all access control devices will display in real time. You can view the details of the card swiping event, including card No., person name, organization, event time, etc.

You can also click the event to view the card holder details, including person No., person name, organization, phone, contact address, etc.

7.11.5 Real-time Access Control Alarm

Purpose:

The logs of access control events will be displayed in real time, including device exception, door event, card reader event, and alarm input.

Click **Access Control Alarm** tab to enter the following interface.

Alarm Type	Alarm Time	Alarm Location	Alarm Content	Operation
Remote: Disarm...	2016-12-16 13:5...	Access Controller	Remote: Disarm...	
Remote: Arming	2016-12-16 13:5...	Access Controller	Remote: Arming	
Remote: Login	2016-12-16 13:5...	Access Controller	Remote: Login	
Remote: Disarm...	2016-12-16 13:5...	Access Controller	Remote: Disarm...	
Remote: Logout	2016-12-16 13:5...	Access Controller	Remote: Logout	
Remote: Login	2016-12-16 13:5...	Access Controller	Remote: Login	
Remote: Arming	2016-12-16 13:4...	Access Controller	Remote: Arming	
Remote: Login	2016-12-16 13:4...	Access Controller	Remote: Login	
Remote: Disarm...	2016-12-16 13:4...	Access Controller	Remote: Disarm...	
Door Locked	2016-12-16 13:4...	Door1	Door Locked	
Unlock	2016-12-16 13:4...	Door1	Unlock	
Remote: Arming	2016-12-16 13:4...	Access Controller	Remote: Arming	
Remote: Login	2016-12-16 13:4...	Access Controller	Remote: Login	
Remote: Disarm...	2016-12-16 13:4...	Access Controller	Remote: Disarm...	

Steps:

1. All access control alarms will display in the list in real time.
You can view the alarm type, alarm time, location, etc.
 2. Click to view the alarm on E-map.
 3. You can click or to view the live view or the captured picture of the triggered camera when the alarm is triggered.
- Note:** For setting the triggered camera, refer to *Chapter 7.10.1 Access Control Event Linkage*.
4. Click **Subscribe** to select the alarm that the client can receive when the alarm is triggered.

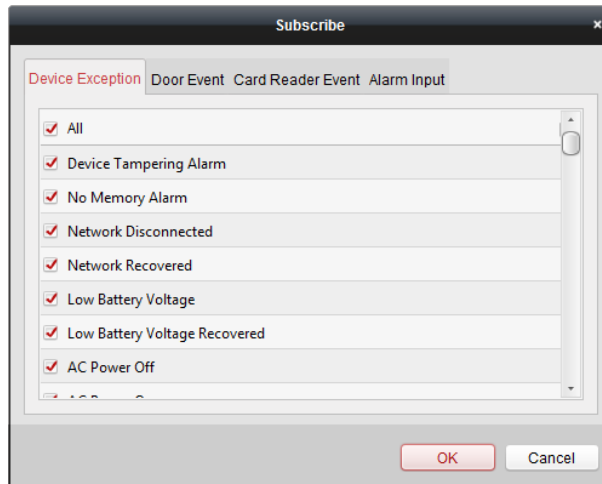

- 1) Check the checkbox(es) to select the alarm(s), including device exception alarm, door event alarm, card reader alarm, and alarm input.
- 2) Click **OK** to save the settings.

7.12 Arming Control

Purpose:

Access Controller - User Manual

You can arm or disarm the device. After arming the device , the client can receive the alarm information from the device.

Steps:

1. Click **Tool->Device Arming Control** to pop up the Device Arming Control window.
2. Arm the device by checking the corresponding checkbox.

Then the alarm information will be auto uploaded to the client software when alarm occurs.

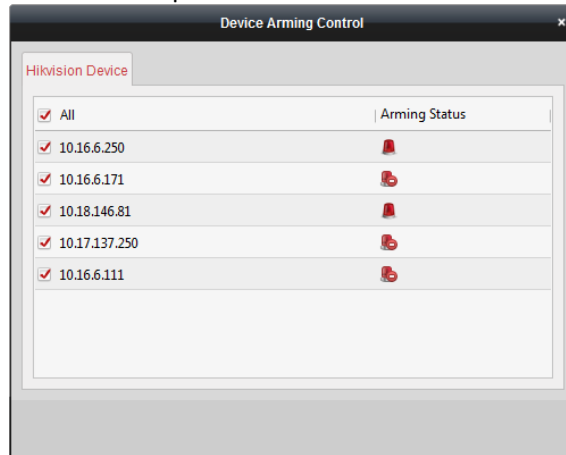

Appendix A Sound Prompt and Indicator

After the card reader is powered on, LED status indicator will turn blue and blink for 1 time. Then it will turn red and blink for 3 times. At last the buzzer will send out a beep sound indicating the starting up process is completed.

During using the card reader, it will send out different sounds prompt and the LED indicator on it have different statuses. You can refer to tables below for detailed information.

Table 7-1 Description of Prompt Sound

Sound Prompt	Description
One beep	RS-485 protocol: Pressing keys prompt; Swiping card prompt; Time out prompt for pressing keys or swiping card. Wiegand protocol: Pressing keys prompt; Swiping card prompt.
Two rapid beeps	The operation of pressing keys or swiping card is valid.
Three slow beeps	The operation of pressing keys or swiping card is invalid.
Rapidly continuous beeps	Alarm of tamper-proof.
Slowly continuous beeps	The card reader is unencrypted.

Table 7-2 Description of LED Indicator

LED Indicator Status	Description
Green and blinking	Card reader is working normally.
Solid green	The operation of pressing keys or swiping card is valid.
Solid red	The operation of pressing keys or swiping card is invalid.
Red and blinking	For RS-485 protocol: Registering failed or card reader is offline. Failed to get key files of PSAM card; Failed to detect the PSAM card.
Red and Keeping rapidly blinking	Available for reading file mode of CPU card: PSAM is not inserted or undetected.

Appendix B Custom Wiegand Rule

Take Wiegand 44 as an example, the setting values in the Custom Wiegand tab are as follows:

Custom Wiegand Name:	Wiegand 44				
Total Length	44				
Transformation Rule (Decimal Digit)	byFormatRule[4]=[1][4][0][0]				
Parity Mode	XOR Parity				
Odd Parity Start Bit		Length			
Even Parity Start Bit		Length			
XOR Parity Start Bit	0	Length per Group	4	Total Length	40
Card ID Start Bit	0	Length	32	Decimal Digit	10
Site Code Start Bit		Length		Decimal Digit	
OEM Start Bit		Length		Decimal Digit	
Manufacturer Code Start Bit	32	Length	8	Decimal Digit	3

Wiegand Data = Valid Data + Parity Data

Total Length: Wiegand data length.

Transportation Rule: 4 bytes. Display the combination types of valid data. The example displays the combination of Card ID and Manufacturer Code. The valid data can be single rule, or combination of multiple rules.

Parity Mode: Valid parity for wiegand data. You can select either odd parity or even parity.

Odd Parity Start Bit, and Length: If you select Odd Parity, these items are available. If the odd parity start bit is 1, and the length is 12, then the system will start odd parity calculation from bit 1. It will calculate 12 bits. The result will be in bit 0. (Bit 0 is the first bit.)

Even Parity Start Bit, and Length: If you select Even Parity, these items are available. If the even parity start bit is 12, and the length is 12, then the system will start even parity calculation from bit 12. It will calculate 12 bits. The result will be in the last bit.

XOR Parity Start Bit, Length per Group, and Total Length: If you select XOR Parity, these items are available. Depending on the table displayed above, the start bit is 0, the length per group is 4, and the total length is 40. It means that the system will calculate from bit 0, calculate every 4 bit, and calculate 40 bits in total (10 groups in total). The result will be in the last 4 bits. (The result length is the same as the length per group.)

Card ID Start Bit, Length, and Decimal Digit: If you use the transformation rule, these items are available. Depending on the table displayed above, the card ID start bit is 0, the length is 32, and the decimal digit is 10. It represents that from bit 0, there are 32 bits represent the card ID. (The length here is calculated by bit.) And the decimal digit length is 10 bits.

Site Code Start Bit, Length, and Decimal Digit: If you use the transformation rule, these items are available. For detailed information, see the explanation of the card ID.

OEM Start Bit, Length, and Decimal Digit: If you use the transformation rule, these items are available. For detailed information, see the explanation of the card ID.

Manufacturer Code Start Bit, Length, and Decimal Digit: If you use the transformation rule, these items are available. Depending on the table displayed above, the manufacturer code start bit is 32, length is 8, and decimal digit is 3. It represents that from bit 32, there are 8 bits are manufacturer code. (The length here is calculated by bit.) And the decimal length is 3.

020000001080620

